

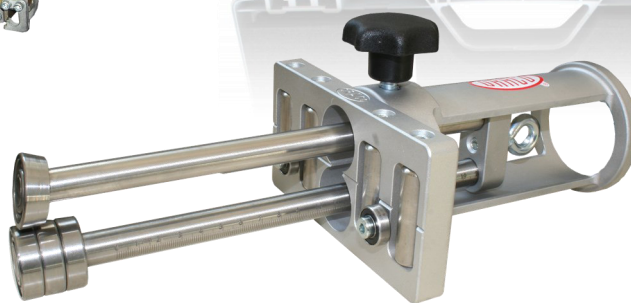

English



... a cut above the rest



Catalogue 20

Machines and tools for sheet metal working

Shears — Nibblers — Standing Seam Roofing Systems

Decoilers — Roll Forming Tools — Benders



www.dracotools.com



- Modern manufacturing** DRÄCO Products have been manufactured in our production in Germany since 1951
- Power tools and standing-seam - technique** DRÄCO produces the original double-sided slitter shear system, a complete range of machines for the standing-seam as well as tools and equipment for metal roofing and standing seam technology
- Experience** In close collaboration with the user products are manufactured close to the market. For more than 60 years DRÄCO continuous developing its cutting systems
- Introduced** DRÄCO, the brand for rational and practical cutting systems, tools and machines
- Source of power** We are able to deliver user friendly products and in high quality. Our hand-held shears are available in cordless (battery), compressed air (pneumatic) and wired (115/230 Volt). Folding machines, roll forming equipment and profiling machines for façades and roof seam in tin man' s quality are available in 230V or 115V
- OEM** You will also find DRÄCO products with private labels for other brands
- Advantage** We always have an open ear for practitioners and users benefit when it comes to improvements and innovations, to bring together a product ready for production. As a family business, we're a strong team. We're in it to win for and with the costumer!
- Quality** We produce robust quality products at a competitive price. We never settle for the first solution that comes by. Our principle is: things can always be smarter and cheaper
- International** DRÄCO products are sold worldwide with success
- Up-to-date and informative** You can find our latest products on the internet at www.dracotools.com as well as important tips, technical information and news

Max Draenert Apparatebau GmbH & Co. KG
Power Tools, Machines for Roof + Wall, Standing-Seam-Technique

Germany

Factory I: Administration
 Production
www.dracotools.com

D-73777 Deizisau
 D-73779 Deizisau

P.O.Box 1120
 Gutenbergstrasse 15-17
 E-Mail

 **T +49-7153-8217-0**
 **F +49-7153-8217-66**
 info@dracotools.com

Content

		Page
Electric Power Tools	A cut above the rest	3
	Which shear for which application?	4
	Slitter Shears	
	Metal Shears SD5-1 & S1001N-1 (body works, C-,CW-profiles)	7
	Metal Shear 1016-1 (universal use)	8
	Metal Shears SD7-1 & 1020-1 (commercial vehicles)	9
	Seam- Metal Shear 3514-2 (roof + wall, ducting)	10
	Radius-Seam-Metal Shear 3514-7R (ducting, small radius)	11
	Metal Shear 3515 (stainless steel and metal stud 14ga.)	12
	Profile Metal Shear 3520 (cable trays)	13
Plastic Shears	Plastic Shears S1002N-1, 3550 (interior)	14
	Cable Tube Shear 3500 (HDPE-pipes and tubes, -tanks)	15
Universal Shear	Universal Shear UVS-1 (vehicle interior, universal use)	16
Nibblers	Corrugated Nibbler 1213-1 (tiled roof profiles)	19
	Corrugated Nibblers 1216-1, 1216-1KL, 1216-1L	20
Pneumatic	Pneumatic Metal Shears	21
Cordless	Cordless-Shears Ni-MH	23
	Cordless-Shears Li-Ion	25
	Spare Parts / Wear & Tear Parts	27
	The Roofing System	29
Double lock and standing seam	Single Seam Power Seamer K9-1-GWS	30
	Power Seamers K9-1, K9-1-WAD	31
K-Series	Round Profile Power Seamer K9-1-ERB	33
	Hand Seamers K5, K6, K7, K8, K8N, K8NL, K11, K12	35
	Bender-Family	37-47
	Mobile Detail Folding Brake K1-AGNU-3	48
	Profiling-Machine PROFIMA K25-PRF, K25-PQLB	49
	Profiling-Machine VARIO PROFI K25-VP	51
	Arch Bending Machine PROFI FORM K25-RBPE	52
	De-Coilers K1-CW, K1-CW/AQ/LSE/S with cutting device	53
	De-Coil and Cross Cut Device K1-CW/AQ, Coil Trolley	54
	Clip Benders K10	55
	Stainless Steel Clips/Cleats / Snow Retention Cleats	56
	ORDERFORM "copy it - fill it out - fax it or mail it"	57
	MAP „How to find us “	58

**A Cut Above the Rest
Way ahead with DRÄCO Tools.**

Since 1951 DRÄCO in Germany has been a partner to the craft, industry and trade. Customers need service and quality. Quality products, practical customer feedback. Design control, training plus dealers and representatives in over 60 different foreign countries. This DRÄCO solution for the various trades and industries, for which we make our machines and tools. Every product is manufactured to the requirements and demands of the customer and is designed and manufactured by the DRÄCO TEAM.

DRÄCO is known world-wide for distortion burr free and safe cutting.

In the double cutting system, all shears can be used as slitting shears and are available with special knives and jaws between 3-8 mm width.

DRÄCO-Tip:

Please ask your dealer for further machinery and tools information for the roof and wall program. DRÄCO tools and machines are designed for reliable, efficient and high performance operation.

Cutting of Metal & Plastic

Double cutting system

When looking at this catalogue you will see metal and plastic shears for many applications. For almost 50 years DRÄCO's quality system and enhanced training has developed robust machines in the double cutting system and other machinery.

This double cutting system with no deformation of the material, burr and serrated free always give a clear view to the marked line, due to waste-exit, to the right side.

Due to this original double cutting system no lubrication is required on the material or cutter.

Allows cutting without distortion



The advantage of the DRÄCO Shears for straight and curved cuts, plus cutting across U-C-L- profiles all without distortion.



Nibbler

DRÄCO Nibblers use a different cutting system. Nibblers hit the material from the top and punch out little pieces, works without any distortion and spark free in all types of materials. The nibblers are usually used for cutting small radius and corrugated materials.

We pride ourselves on our reputation, for delivering quality products with high standards to our professional partners, distributors and our end user customers.



All machines and tools in this catalogue can be changed for improvement, without prior notice.

Which



- Shear for which application?

● ideal ○ useable * for trapezoidal sheets ** for UA-Profiles also

Tools	Field	Capacity up to mm	Auto-motive	Dry wall industrie	Roof wall Facade	Ducting Housing technology	Aviary Mesh & Wire	Energy Recycling	Engineering	Plastics Pipes, Tubes Tanks Interieur
Electric:										
SD5-1		Steel 1,0	●	○	●	○				
S1001N-1		Steel 1,3	○	●	●	●			●	
1016-1		Steel 1,6	○	●	●	○	○	○	●	
1020-1		Steel 2,0	○	●	○		○		●	
SD7-1		Steel 2,0	●	○			○		●	○
3514-2		Steel 2,0			●	●	●	●		○
3514-7R		Steel 2,0			○	●	○			○
3514-7WB		Steel 2,0	○		○	●	○			○
3515		Steel 2,3		● **	○		○		●	
3520		Steel 2,0		○	○		○	●	●	○
S1002N-1		Plastic								●
3550		Plastic								●
3500		Plastic								●
UVS-1		Steel 1,0	●		○		○		○	●
Nibblers:										
1213-1		Steel 1,3			● *					○
1216-1		Steel 1,6			● *					○
Cordless:										
AK 3010		Steel 1,0	●		●					○
AK 3013		Steel 1,3		●	●	●	○		●	○
AK 3016		Steel 1,6		●	○		○		●	○
AK 3514-2		Steel 2,0			●	●	●	●		○
AK 3514-7R		Steel 2,0			○	●	○			○
AK 3515		Steel 2,0		● **	○		○		●	○
AK 3520		Steel 2,0		○	○		○	●	●	○
AK 3000		Plastic								●
AK 3002		Plastic								●
Pneumatic:										
1910		Steel 1,0	●		●					
1913		Steel 1,3		●	●	●	○		●	
1920		Steel 2,0								
1950		Plastic								●
19/3514-2		Steel 2,0			●	●	●	●		
19/3514-7R		Steel 2,0			○	●	○			
19/3515		Steel 2,3		● **	○		○		●	○
19/3520		Steel 2,0		○	○		○	●	●	

For specific cutting problems and material types, please ask our application department

Slitter Shears



Industry solution DRÄCO slitter shears - roof & wall / facade construction / hall / drywall / ventilation & air-conditioning / electrical / body / apparatus and housing construction

DRÄCO Slitter Shears and your work will be easy and trouble free!

Our shears offer distortion and burr-free cutting without the need for laborious edge dressing. Long life, without the need for frequent knife replacement. Distortion free cutting without time-consuming smoothing. Spark free work without exposure to sparks. Clean distortion free cuts without sharp edges in flat and profiled materials including seam and stiffening. Cutting of curves and straight lines, as well as separation of various materials without changing blades. Cordless options are available to match mains electric machines.

The alternative to the angle grinder is no alternative, but pure reason!

Safety at work in Drywall installation:

Flying sparks from angle grinders can cause serious damage – use DRÄCO slitter shears S1001N-1, 1016-1 and/or 3515. Trying to save money using an angle grinder does not always save money.

Breaking grinding discs can cause damage to windows and tiles, oxidation in walls of wet-rooms, sharp cutting edges needing de-burring.

DRÄCO-slitter shears provide the necessary security and time savings at the working site and in the building. With up to 2000 meters of cutting per knife and high cutting speed, a shear would be the better option.

Air Conditioning and Ventilation:

DRÄCO seam metal shears 3514-2 and 3514-7R provide maximum performance for this trade. Whether as a power tool, cordless, or as the compressed air version they are a good choice when it comes to cutting steel and folded connection.

Roof & Wall / Façade Construction / Hall Construction:

On the roof and wall DRÄCO electric shears and nibblers always make a professional cut. Especially our Cordless tools are increasingly popular in these industries. The steel metal shear AK 3013 is ideal for long straight cuts and the trapezoidal Nibbler AK 3160 for corrugated and trapezoidal panels in façades and halls. Universal Metal Slitter Shear AK 3010 and Seam Metal Shear AK 3514-2 for Tinsmith (sheet metal work) and construction/fabrication.

Long cables on the roof, on site or in large halls are becoming a thing of the past. With the extreme endurance of the latest generation Li-Ion Cordless Slitter Shears make the decision easy. Fast charging and a second battery – forget the cables.

Electrical Engineering:

The Electrician is able to cut cable trays in situ with the DRÄCO 3520 cable tray shear. The clean cut ensures cables on the tray are not damaged.

Bodywork / Appliances / Ducting and Enclosing:

Swarf and sparks during cutting can cause damage to interiors but by using the DRÄCO SD5-1 or SD7-1 shears, metal removed during cutting can be pulled from the shear. With these shears you can cut sheet to be welded and even folded fabrications, spark free and no chips. DRÄCO shear 1020-1 also cuts machine covers up to 2 mm steel and 3 mm aluminium.

Our devices are optimized. According to the motto "the best tool to everybody". But that doesn't mean they are not suitable for other trades too. The range is greater than specified and applications can overlap also. See page 4 also "Which Shear for which application".



Metal Slitter Shears / up to 1,0 and 1,3 mm

Common features:

- cuts without distortion or straightening of formed parts
- burr free cutting
- no finishing of the edges is required
- accurate cutting along a marked line
- single-side trimming is possible
- working speed up to 9 m/min
- cutting of U-,C- and L-profiles
- clear view to scribed line or template
- long life tool
- easy, one hand, operation
- simple and safe to use
- noise under limit regulations
- insulated and suppressed motor

- can cause **no injury while in motion!**



Optional adjustable guide S/01, for precisely straight cut strips without marking a line 100, 250 and 500 mm

Advantages SD5-1:

- short curves possible
- ideal for tinsmiths and body-coach workshops
- ideal for sheet metalwork
- installation of car sun roofs
- support-roller keeps the shear flat
- acoustic ceiling metal tiles, lighting fixtures
- cutting extruded and formed shapes
- U-,C- and L- profiles



metal box 18000

Advantage S1001N-1:

- ideal for installations, air conditioning, ducting, aircraft manufacturing
- for straight and curved patterns
- stationary cutting in a vice possible
- ideal for U-,C- and L- profile cutting cable trays and steel studs
- an indispensable tool for any other applications.

SD5-1

Good Curve ability



Also available:

- ➔ cordless, type AK 3010 (12 or 18 Volt)
- ➔ pneumatic, type 1910

S1001N-1



Also available:

- ➔ cordless, type AK 3013 (12 or 18 Volt)
- ➔ pneumatic, type 1913



cut-outs from drilled starting holes



cutting of formed parts

DRACO Metal Shears		type	SD5-1	S1001N-1
max. cutting capacity		Art.no.:	61000-1	61010-1
steel	400 N/mm ²	mm/ga.	1,0 / 19	1,3 / 18
stainless steel	600 N/mm ²	mm/ga.	0,7 / 21	1,0 / 19
stainless steel	800 N/mm ²	mm/ga.	0,5 / 24	0,7 / 21
aluminium	250 N/mm ²	mm/ga.	1,5 / 16	2,0 / 14
tightest radius		mm/ "	50 / 2	100 / 4
working speed		±m/min	9	9
strokes		min ⁻¹	3900	3900
motor capacity		W	300	300
weight		kg	1,6	1,6
min. start hole diameter		mm	10	11

SD5-1		S1001N-1	
spare parts		spare parts	
knife	01011	knife	01001
set of jaws	BG13574/1	set of jaws	BG10600
knife-pin set	BG12555	knife-pin set	BG12555
optional accessories			
metal box			18000
adjustable guide S/01	up to 100 mm		10059
adjustable guide S/01	up to 250 mm		10060
adjustable guide S/01	up to 500 mm		10061
support roller			BG10076

all units are ready to use

BG=Set

other voltages available



Metal Slitter Shear / up to 1,6 mm

1016-1

Common features:

- cutting without distortion or straightening of formed parts
- burr free cutting
- no finishing of the edges is required
- accurate cutting along a marked line
- single-side trimming is possible
- working speed up to 5 m/min
- cutting of U-, C- and L-profiles
- open view to scribed line or template
- long life tool
- easy, one hand, operation
- simple and safe to use
- noise under limit regulations
- an insulated and suppressed motor

- can cause **no injury while in motion**

Advantages 1016-1:

- fast, cheap and universal shear for installers, assembly, crafts, and drywall profiles
- the light, compact and robust shear is used in the assembly as well as in mass production
- linear guide systems can be used to mount the slitter

For UA-profile (2 mm) use type 3515.



Also available:

➔ cordless, type AK 3016 (12 or 18 Volt)



metal box 18000



Optional adjustable guide S/01, for precisely straight cut strips without marking a line 100, 250 and 500 mm



cut-outs from drilled starting holes



cutting of formed parts

DRÄCO Metal Shear		1016-1
max. cutting capacity		<i>Art.no.:</i> 61016-1
steel	400 N/mm ² mm/ga.	1,6 / 16
stainless steel	600 N/mm ² mm/ga.	1,3 / 18
stainless steel	800 N/mm ² mm/ga.	1,0 / 19
aluminium	250 N/mm ² mm/ga.	2,5 / 12
tightest radius	mm	140
working speed ±	m/min	7
strokes	min ⁻¹	3900
motor capacity	Watt	300
weight	kg	1,6

all units are ready to use

1016-1			
spare parts			
knife standard	01013	knife serrated	01013z
set of jaws	BG13074		
knife-pin set	BG12555		
optional accessories			
metal-box	18000		
adjustable guide S/01	up to 100 mm	10059	
adjustable guide S/01	up to 250 mm	10060	
adjustable guide S/01	up to 500 mm	10061	
support roller (metal)	BG10077		

BG=Set

other voltages available



Metal Slitter Shears / up to 2,0 mm SD7-1

the universal cutter for straight lines and curves - ideally in the automotive and commercial vehicle bodywork



1020-1



Common features:

- cutting without distortion or straightening of formed parts
 - burr free cutting
 - no finishing of the edges is required
 - accurate cutting along a marked line
 - single-side trimming is possible
 - working speed up to 5 m/min
 - cutting of U-,C- and L-profiles
 - clear view to scribed line or template
 - long life tool
 - easy, one hand, operation
 - simple and safe to use
 - noise under limit regulations
 - an insulated and suppressed motor
- **can cause no injury while in motion**
- the strong shears for cutting of machine covers sheet metal etc. Anywhere where a higher capacity is appreciated.

Advantages SD7-1:

Usable like SD5-1, but double capacity. Ideal for utility vehicles. Cutting steps and seams. Good curve ability. Standard equipped with HSS-knife!



Advantages 1020-1:

This is an ideal shear for: sheet-metal workshops, air conditioning, control cabinet fabrication, external wall cladding.



Optional adjustable guide S/01, for precisely straight cut strips without marking a line 100, 250 and 500 mm

Also available:

→ pneumatic, type 1920



cut-outs from drilled starting holes



cutting of formed parts

DRACO Metal Shears		type	SD7-1	1020-1
max. cutting capacity	<i>Art.no.</i>		61047	61040-1
steel	400 N/mm ²	mm/ga.	2,0 / 14	2,0 / 14
stainless steel	600 N/mm ²	mm/ga.	1,5 / 16	1,5 / 16
stainless steel	800 N/mm ²	mm/ga.	1,3 / 18	1,3 / 18
aluminium	250 N/mm ²	mm/ga.	3,0 / 10	3,0 / 10
tightest radius		mm/ "	50 / 2	200 / 8
working speed ±		m/min	5	5
strokes		min ⁻¹	2200	2200
motor capacity		W	500	500
weight		kg	1,8	1,8
min. start hole diameter		mm	12	14

SD7-1		1020-1	
spare parts		spare parts	
knife	37140S7	knife	010135
set of jaws	BG37222	set of jaws	BG35146
knife-pin set	BG35149	knife-pin set	BG35155
optional accessories			
metal box			18000
adjustable guide S/01	up to 100 mm		10059
adjustable guide S/01	up to 250 mm		10060
adjustable guide S/01	up to 500 mm		10061
support roller (metal)			BG10077

all units are ready to use

BG=Set

other voltages available



Seam Metal Shear / up to 2,0 mm
ideal for multiple seams
 spiral ducting, seams, mesh & wire, etc.

3514-2

Cold and emission-free operation

Common features:

- cuts formed parts without distortion or straightening
- burr free cutting
- no finishing of the edges is required
- accurate cutting along a marked line
- single-side trimming is possible.
- working speed up to max. 5 m/min.
- cutting of U-,C- and L- profiles
- clear view to scribed line or template
- long life tool
- easy, one hand, operation
- simple and safe to use
- can cause no injury while in motion
- noise under limit regulations
- insulated and suppressed motor
- almost no maintenance necessary
- knife and jaws can be reground
- parts are standardized and interchangeable

Ideal for cutting:

- spiral-/round ducting
- transverse grooves, first folds and grooves from sheet iron
- roof & wall claddings
- roof folds
- roller shutter boxes, caps
- through 6 times folded double lock and Pittsburgh Seams
- mesh and wire
- aviary and cage construction
- sheet metal
- hole range from lead to stainless steel
- non-ferrous materials (aluminium, copper, zinc)
- painted or coated aluminium



cutting through double lock seam
6 times folded at the ridge or gutter

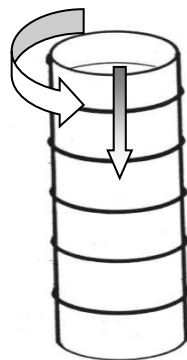

Spiral ducting

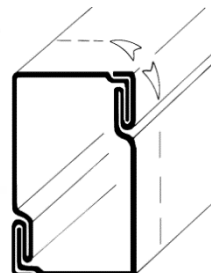

Pittsburgh-seam

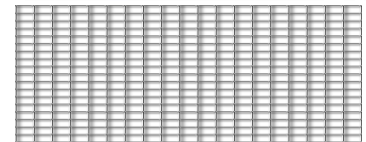

mesh and wire, cutting without sharp points

Also available:

- ➔ cordless, type AK 3514-2 (12 or 18 Volt)
- ➔ pneumatic, type 19/3514-2

DRACO Seam Metal Shear		type	3514-2
max. cutting capacity		Art.no.	61070
steel	400 N/mm ²	mm/ga.	2,0 / 14
stainless steel	600 N/mm ²	mm/ga.	1,5 / 16
stainless steel	800 N/mm ²	mm/ga.	1,3 / 18
aluminium / non ferro	250 N/mm ²	mm/ga.	3,0 / 10
duct- & Pittsburgh Seam	400 N/mm ²	mm/ga.	4 x 0,90 / 20
double lock seam	250 N/mm ²	mm/ga.	6 x 0,75 / 21
tightest radius		mm/inch	200 / 8
working speed ±		m/min	5-7
strokes		min ⁻¹	2400
motor capacity		W	500
weight		kg	2

3514-2	
spare parts	
knife serrated heavy duty	035141
set of jaws	BG35146
knife-pin set	BG35055
optional accessories	
metal box	18000



all units are ready to use

BG=Set

other voltages available



Radius Seam Metal Shear / up to 2,0 mm
Ideal for small radius through multiple seams
and/or heavy duty

Cold and emission-free operation

3514-7R

Common features:

- cuts without distortion or straightening of formed parts
- burr free cutting
- no finishing of the edges is required
- accurate cutting along a marked line
- single-side trimming is possible.
- clear view to scribed line or template
- long life tool
- easy, one hand, operation
- simple and safe to use
- noise under limit regulations
- insulated and suppressed motor
- almost no maintenance necessary
- knife and jaws can be reground
- parts are standardized and interchangeable

- no flying sparks!
- no dangerous handling with angle grinders!
- Interior suitable
- accident free!



Good curve ability

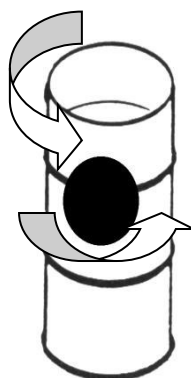
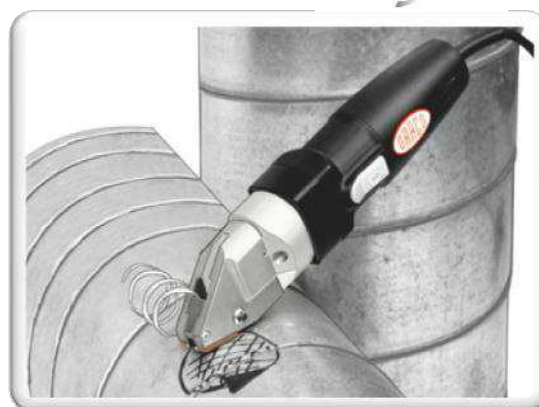

spiral ducting

Ideal for:

- cutting slots in ducting and metals of all kinds
- Air and climate technology installers
- TRUCK workshops
- metalworking companies etc.

starting hole 12-14 mm Ø
 accurate cutting along a marked line

Also available:

- ➔ cordless, type AK 3514-7R
- ➔ pneumatic, type 19/3514-7R

DRACO Radius Seam Metal Shear		type	3514-7R
max. cutting capacity		Art.no.	61080
steel	400 N/mm ²	mm/ga.	2,0 / 14
stainless steel	600 N/mm ²	mm/ga.	1,5 / 16
stainless steel	800 N/mm ²	mm/ga.	1,3 / 18
aluminium / non ferro	250 N/mm ²	mm/ga.	3,0 / 10
duct- & Pittsburgh Seam	400 N/mm ²	mm/ga.	4 x 0,75 / 21
tightest radius		mm/ "	45 / 1¾
working speed ±		m/min	5-7
strokes		min ⁻¹	2400
motor capacity		Watts	500
weight		kg	2
starting hole		Ø mm	14

3514-7R	
spare parts	
knife heavy duty	371401
set of jaws	BG37222
knife-pin set	BG35055

optional accessories	
metal box	18000
knife serrated heavy duty	371401Z



all units are ready to use

BG=Set

other voltages available



Metal stud- & stainless steel shear / up to 2,3 mm

Ideal for UA-profiles and really hard jobs

Common features:

- cuts without distortion or straightening of formed parts
- burr free cutting
- no finishing of the edges is required
- accurate cutting along a marked line
- single-side trimming is possible.
- clear view to scribed line or template
- long life tool
- easy, one hand, operation
- simple and safe to use
- insulated and suppressed motor
- almost no maintenance necessary
- knife and jaws can be reground
- parts are standardized and interchangeable

- no flying sparks!
- no dangerous handling with angle grinders!
- Interior suitable
- accident free!
- noise under limit regulation
- ideal for cutting stainless steel
- high service life
- standard high strength knife

Ideal for:

- reinforcing profiles, C -& CW profiles in the drywall, because soft and low-vibration cutting



- railings, stair construction, Thermo products, chemical and pharmaceutical equipment



- **Stainless steel machining:** commercial kitchen, food service & catering equipment manufacturing



3515



Dry wall
Metal stud / UA-profiles

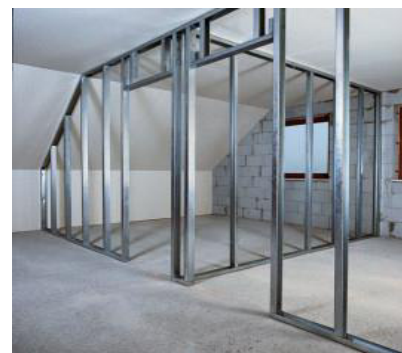

Also available:

- ➔ cordless, type AK 3515 Li-Ion 18 Volt
- ➔ pneumatic, type 19/3515



cut-outs from drilled starting holes 12-14mm

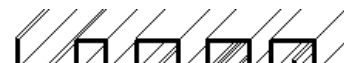

cutting of shaped parts

DRACO V2A Metal Shear		3515	
max. cutting capacity		Art.no.	61063
steel	400 N/mm ²	mm	2,3
stainless steel	600 N/mm ²	mm	1,8
stainless steel	800 N/mm ²	mm	1,5
aluminium	250 N/mm ²	mm	3,0
tightest radius		mm	200
working speed ±		m/min	5-7
strokes		min ⁻¹	2400
motor capacity		Watt	500
weight		kg	2

all units are ready to use

3515	
spare parts	
knife heavy duty	035151
set of jaws	BG35146
knife-pin set	BG35055
optional accessories	
metal box	18000
support roller (metal)	BG10077



BG=Set

other voltages available



Profile metal shear / up to 2,0 mm
Ideal for Cable Trays

3520



Common features:

- cuts without distortion or straightening of formed parts
- burr free cutting
- no finishing of the edges is required
- accurate cutting along a marked line
- single-side trimming is possible.
- clear view to scribed line or template
- long life tool
- easy, one hand, operation
- simple and safe to use
- insulated and suppressed motor
- almost no maintenance necessary
- knife and jaws can be reground
- parts are standardized and interchangeable
- no flying sparks!
- no dangerous handling with angle grinders!
- Interior suitable
- accident free!

Ideal for:

- all installation shops, examples: cable trays, coated cable trays, cable ladders, spiral tubing, mesh and wire
- heating and ventilating
- ventilation system fabrication, partitions
- construction-plants, etc.

Advantages:

THE metal-shear for U-C-L profiles up to 2 mm. 500 watt motor. Bend folded cable trays cutting in one operation. Even cutting of **stainless steel** cable trays without any problems (up to 1,5 mm / 18 ga.). Optional knife serrated for coated materials mitring cuts of cable trays available.

Electrical engineering:
Cable Trays

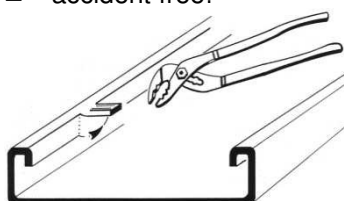

some profiles need lifting up at the side with a pair of pliers

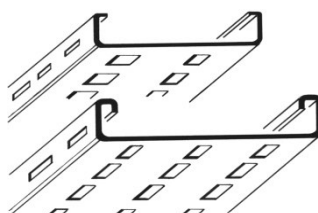

Also available:

- cordless, type AK 3520 (12 or 18 Volt)
- pneumatic, type 19/3520

DRACO Profile Metal Shear		3520
max. cutting capacity	Art.no.	61060
steel	400 N/mm ² mm	2,0
stainless steel	600 N/mm ² mm	1,5
stainless steel	800 N/mm ² mm	1,3
aluminium / non ferro	250 N/mm ² mm	3,0
tightest radius	mm	200
working speed ±	m/min	5-7
strokes	min ⁻¹	2400
motor capacity	Watt	500
weight	kg	2

3520	
spare parts	
knife heavy duty	035201
set of jaws	BG35020
knife-pin set	BG35055
optional accessories	
metal box	18000
serrated knife	035271
support roller (metal)	BG10077

all units are ready to use

BG=Set

other voltages available



Plastic Shears

S1002N-1

Common features:

■ **Splinter proof cutting of all synthetic resin and laminated plastic-materials:**

Pk-Tex, Textolite, Formica, Perstorp, Ultrapas, Resopal, Celamin, Hornitex, Getalit, Novatex. Thermopal, Tacon, etc. **

■ **Fuzz and dust free cutting**
Hardboard, Pavatex, Renovite, Karton, Masonit, Silvacolor, Hornitex, Glasal, etc. **

■ **Also:**
Inlaid, Linoleum, Veneer, etc., Deliflex, Linoleum, Mipolam, PVC, Polyester (dust free!), etc. **

■ flush trimming of projected edges with side guide

■ cutting of strips and edge-bands

■ NO PLEXIGLAS !

- easy, one hand, operation
- simple and safe to use
- insulated and suppressed motor
- accurate cutting along a marked line
- clear view to scribed line or template
- long life tool
- can cause no injury while in motion
- noise under limit
- low maintenance
- knives and jaws can be exchanged or re-sharpened



Side guide for edge trimming inclusive



Slitting of corrugated polyester with optional guide BG20065

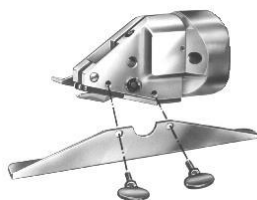

assembling side guide with two wing screws



adjustable guide for cutting strips or edge-bands



set of blocks, for straight cutting of corrugated plastics, BG 20065

3550



Quick on & off side guide for flush trimming

Also available:

- ➔ 18 Volt cordless, type AK 3550 Li-ion
- ➔ pneumatic, type 1950

DRACO Plastic Shears		S1002N-1	3550
max. cutting capacity	Art.no.	61310-1	61320
Board etc.	mm/ga.	5,0	5,0
PVC, ABS, PP, etc.	mm/ga.	3,0 / 10	3,5 / 9
Polyester, GFK, Formica, etc.	mm/ga.	2,0 / 14	3,0 / 10
Teflon, ABS, GFK, PVC etc.		better with 3550	
tightest radius	mm/°	175 / 7	175 / 7
working speed	m/min	6	0 - 5
strokes	min ⁻¹	3000	2400
motor capacity	Watts	200	500
weight	kg	1,6	2

S1002N-1 & TYP II		3550	
spare parts		spare parts	
knife	01002	knife	01002
set of jaws	BG20600	set of jaws	BG20601
knife-pin set	BG12555	knife-pin set	BG12555
optional accessories			
metal box			18000
adjustable guide S/02	up to 100 mm		20062
adjustable guide S/02	up to 250 mm		20063
adjustable guide S/02	up to 500 mm		20064
set of blocks for corrugated plastics			BG20065

all units are ready to use

** Trademarks

BG=Set

other voltages available



Plastic Shear Pipe Slitter

**For all energy suppliers
No harmful fumes when cutting**

Cutting of plastic tanks

3500

Plastic shear 3500 is used for cutting open plastic outer casings of fiber optic cables longitudinally for repair



Common features:

- cutting capacity in plastics up to 6 mm material, for example: **HDP pipes**
- easy, one hand operation
- simple and safe to use
- insulated and suppressed motor
- accurate straight cutting due to guide pin
- clear view to scribed line or template
- long life tool
- noise under limit regulations
- low maintenance
- **knife doesn't damage fibre optic cables**
- **straight longitudinally cuts due to guide pin behind the knife**



Also available:

→ cordless, type AK 3000 Li-Ion

DRACO Plastic Shear		3500
max. cutting capacity	<i>Art.no.</i>	61330
HDPE, Telecom cables	mm	6,0
PVC, ABS, PP, etc.	mm	3,5
Polyester, GFK, Formica, etc.	mm/ga.	2-3 / 14-10
tightest radius	mm/inch	175 / 7
working speed	m/min	5
strokes	min ⁻¹	2400
motor capacity	Watts	500
weight	kg	2

3500			
spare parts			
knife	30068	guide pin	30078
set of jaws	BG30074		
knife-pin set	BG12555		
optional accessories			
metal box			18000
adjustable guide S/02	up to 100 mm		20062
adjustable guide S/02	up to 250 mm		20063
adjustable guide S/02	up to 500 mm		20064

all units are ready to use

BG = Assembly group

other voltages available



Universal Shear

UVS-1



Common features:

- cuts without distortion or straightening of formed parts
- burr free cutting
- no finishing of the edges is required
- accurate cutting along a marked line
- single-side trimming is possible
- working speed up to 9 m/min
- clear view to scribed line or template
- long life tool
- easy, one hand operation
- simple and safe to use
- noise under limit
- insulated and suppressed motor
- **can cause no injury while in motion!**
- all-purpose use for different materials
- short curves possible
- ideal for thin sheet metalwork
- acoustic ceiling metal tiles, lighting fixtures

Ideal for:

The Universal Shear UVS-1 is mostly used for interior-work, in buses, vans & trucks, to line or panel the roof, side or floor.

Advantages:

Tightest radius 30 mm to the left or right, depending on the thickness of the material. Machine has very good curve ability. The chip comes out at the top of the shear as a spiral strip which protects the materials surface. Optional adjustable guides S/01 (for metal) or S/02 (for plastics) for precisely straight cut strips without marking a line are available too.



for various interior work in buses, vans etc.



adjustable guide S/01 for metal



adjustable guide S/02 for plastics



cut-outs from drilled starting hole

DRACO Universal Shear		UVS-1
max. cutting capacity	<i>Art.no.</i>	61340-1
steel	400 N/mm ² mm/ga.	1,0 / 19
stainless steel	600 N/mm ² mm/ga.	0,7 / 23
stainless steel	800 N/mm ² mm/ga.	0,5 / 25
non ferro	250 N/mm ² mm/ga.	1,3 / 18
Sowaflex ®	mm	5,0
PU, ABS etc., plastics	mm	3,0-5,0
cardboard etc.	mm	6,0
sealing materials	mm	6,0
tightest radius plastics	mm/ °	30 / 1¼
tightest radius metal	mm/ °	50 / 2
strokes	min ⁻¹	3000
motor capacity	Watts	200
weight	kg	1,6

UVS-1 spare parts	
knife UVS standard	07014
knife UVS serrated	07016
set of jaws	BG13574/1
knife-pin set	BG12555
optional accessories	
metal box	18000
adjustable guide S/01 up to 100 mm	10059
adjustable guide S/01 up to 250 mm	10060
adjustable guide S/01 up to 500 mm	10061
support roller	BG10076
adjustable guide S/02 up to 100 mm	20062
adjustable guide S/02 up to 250 mm	20063
adjustable guide S/02 up to 500 mm	20064

all units are ready to use

BG = Assembly group

other voltages available

Nibblers



Industry solution: Nibblers - Roof & Wall / Facade / Hall Construction

Nibblers are simple ideally suited for wavy and trapezoidal materials.

Ideal for cutting large panels without sparks, preventing uncontrolled flying sparks and damage to the coating of the sheet. Cutting recesses in corrugated sheet facades and trapezoidal sheet for pipes and channels that lead out of the building, is one of the priority tasks. Projecting corrugated sheets, profiled sheets and metal tile sheets (1213-1) can be adjusted to the facade straight and in curves.

Safety at work: Using angle grinders is not the safest or most economical option. Sparks and exposure to angle grinder make the decision for nibblers in this area very easy. Who believes to save money by using angle grinders is charging himself greatly. Breaking discs, damage of plate coating, oxidation, the tilting and the wear and tear on the hollow trapezoidal sheet are taken into account when comparing. DRÄCO nibblers offer the necessary quality and safety on the construction site.

DRÄCO offers three machine types for the cutting of a variety of materials such as mild steel, stainless steel, non-ferrous metals and plastics. All three provide distortion free cutting, easy guidance and unsurpassed manoeuvrability as the PN 4320 shows us.

Corrugated and trapezoidal profiled sheet-metal can be cut cleanly without jamming using nibblers 1213-1, 1216-1. A wide open angle allows the tools axis to tilt up to 60 degrees in either direction while cutting. This is sufficient for most common shapes and depths.

The most flexible and **universal nibbler** for corrugated materials is the **1213-1**.

DRÄCO Nibblers work with a punching cut. Downward chip discharge guarantees clear view of the working area.

The DRÄCO nibblers offer a superior, emission free and environmentally safe alternative to traditional methods of cutting with abrasive wheels, reciprocating blades or gas and plasma torches. Easy operation makes the DRÄCO nibblers an ideal work companion.

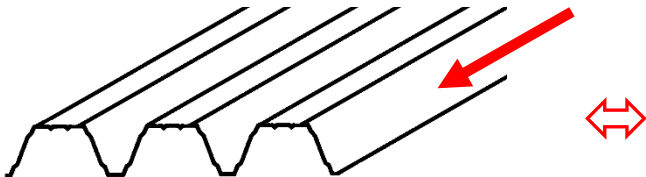

Our advice:

For speedy cutting of corrugated material **length wise**, it's ideal to use the DRÄCO metal shear 1016-1 up to 1,6 mm, or 1020-1 up to 2,0 mm, depending on the requested material thickness.



Corrugated Nibbler 1213-1

Cold and emission-free operation

Common features:

- extremely manoeuvrable, easy operation
- fast, safe cutting of corrugated, trapezoidal and square sheet profiles
- high cutting capacity
- chips ejected below material, guarantees clear, unimpeded view of the working area and the cutting line
- cuts all materials that can be punched, such as mild steel, stainless steel, aluminium, non-ferrous metals and plastics
- crosswise and angle cut of corrugated materials

- Ideally suited for all trapezium sheet materials up to 85 mm depth/height
- optional Profile Set up to 160 mm
- optimum ease of use, excellent manoeuvrability and curve-going

- high cutting speed for rapid work
- tool free adjustment of the working direction in steps of 45°
- long life tools
- superior, emission-free operation
- free from sparks or heating
- no damage or scratch marks to painted or coated materials
- simple tool changing without requiring re-adjustment



Profile Set
160 mm



**Quick
IN-OUT
tool free!**

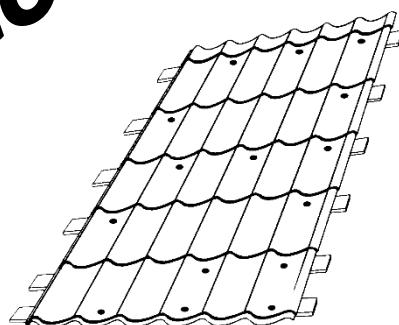

metal tiles



corrugated & trapezoidal sheets



metal box 18000

DRACO Corrugated Nibbler		type	1213-1
max. cutting capacity		<i>Art.no</i>	61203-1
steel	400 N/mm ²	mm/ga.	1,3 / 18
stainless steel	600 N/mm ²	mm/ga.	0,5 / 25
non ferro	250 N/mm ²	mm/ga.	1,0 / 19
depth of profiles max.		mm/inch	85 / 3 1/3
tightest radius		mm/inch	30 / 1 1/4
working speed		m/min	1,3
strokes		min ⁻¹	1500
motor capacity		Watts	350
weight		kg	1,8

1213-1	
spare parts	
punch	12130002
die	12130003
optional accessories	
Profile Set 160 mm cpl.	12160005
metal box	18000
nibbling oil (bottle 1,0L)	20198
nibbling oil (spray 0,5L)	20199

all units are ready to use

other voltages available



Corrugated Nibbler 1216-1

Cold and emission-free operation

Flexible nibbler for sheet metals, trapezoidal sheet metals, corrugated sheet metals and profiles.

Common features:

- HIGH-POWER-MOTOR for unmatched performance and durability
- unique nibbler for sheet metal up to 1,6 mm
- ideally suited for all trapezium sheet materials up to 85 mm deep
- very low operating costs by die and punch with long service life
- optimum ease of use, excellent manoeuvrability and curve-going
- high cutting speed for rapid work
- tool free adjustment of the working direction in steps of 45°
- simple tool changing without requiring readjustment
- also overlay areas can be cut



Profile Set
160 mm



**Quick
IN-OUT
tool free!**



Standard



and

with Profile Set 160

- Use the optional profile set 160 for trapezoid sheet metals with deep channels of from 85 to 160 mm.



metal box 18000



Other versions:

Type		Art.nr:
1216-1KL	incl. Profile Set 160=short+long	61207-1KL
1216-1L	with Profile Set 160 only = long	61207-1L

DRACO Corrugated Nibbler		type	1216-1
max. cutting capacity		Art.no.	61207-1
steel	400 N/mm ²	mm/ga	1,6 / 16
stainless steel	600 N/mm ²	mm/ga	1,0 / 19
stainless steel	800 N/mm ²	mm/ga	0,7 / 21
non ferro	250 N/mm ²	mm/ga	2,5 / 12
depth of profiles max.		mm/inch	85 / 6 1/3
tightest radius		mm	35 / 1 1/3
working speed		m/min	1,9
strokes		min ⁻¹	1500
motor capacity		Watts	350
weight		kg	1,8

1216-1	
spare parts	
punch + die (set)	12160001
punch	12160002
die	12160003
punch for Profile Set 160	12160102
die for Profile Set 160	41577
optional accessories	
Profile Set 160 mm cpl.	12160005
metal box	18000
nibbling oil (bottle 1,0L)	20198
nibbling oil (spray 0,5L)	20199

all units are ready to use

other voltages available



Pneumatic Slitter Metal Shears 1910, 1913 & 1920

Common features:

- cuts without distortion or straightening of formed parts
- burr free cutting
- no finishing of the edges is required
- accurate cutting along a marked line
- single-side trimming is possible
- working speed up to 9 m/min
- cutting of U-, C- and L-profiles
- clear view to scribed line or template
- long life tool
- easy, one hand, operation
- simple and safe to use
- noise under limit
- low air consumption
- ideal for application in hazardous areas

Advantage of 1910:

- short curves possible
- ideal for body-coach workshops
- installation of car sun roofs
- support-roller keeps the shear flat
- shear head equivalent to SD5-1



Advantage of 1913:

- ideal for installation, air conditioning, ducting, aircraft manufacturing
- for application in hazardous (explosive) areas
- ideal for U-, C-, & L-profile cutting
- shear head equivalent to S1001N-1



Advantage of 1920:

- rugged tool for higher cutting capacity
- ideal for U-, C-, & L-profile cutting
- shear head equivalent to 1020-1
- for application in hazardous (explosive) areas



Optional adjustable guide S/01 for precisely straight cut strips (100, 250, 500 mm)



optional metal box
(Item.no. 18000)



cut-outs from drilled starting hole 10-14mm



cutting of shaped parts

DRACO Metal Shears		type	1910	1913	1920
max. cutting capacity		Art.no.:	62030-1	62040-1	62050-1
steel	400 N/mm ²	mm/ga.	1,0/19	1,3/18	2,0/14
stainl. steel	600 N/mm ²	mm/ga.	0,7/21	1,0/19	1,5/17
stainl. steel	800 N/mm ²	mm/ga.	0,4/24	0,7/21	1,3/18
aluminium	250 N/mm ²	mm/ga.	1,5/18	2,0/14	3,0/10
tightest radius		mm/ "	50/2	100/4	200/8
working speed	max. ±	m/min	9	9	9
strokes		min ⁻¹	3000	3000	3000
air-consumption at 6 bar/min.		m ³ ±	0,18	0,18	0,18
motor capacity		Watts	200	200	200
weight		kg	1,3	1,3	1,3
noise		db(A)	78	78	78

spare parts	1910	1913	1920
knife	01011	01001	010135
set of jaws	BG13574/1	BG10600	BG13574
knife-pin set	BG12555	BG12555	BG12555

optional accessories		
adjustable guide S/01	up to 100 mm	10059
adjustable guide S/01	up to 250 mm	10060
adjustable guide S/01	up to 500 mm	10061
support roller (plastic)		BG10076
support roller (metal)		BG10077
metal box		18000

all units are ready to use

BG=Set



Pneumatic Slitter Metal Shears 19/3514-2, 19/3514-7R & 19/3520

Common features:

- cuts without distortion or straightening of formed parts
- burr free cutting
- no finishing of the edges is required
- accurate cutting along a marked line
- single-side trimming is possible
- working speed up to 9 m/min
- cutting of U-, C- and L-profiles
- clear view to scribed line or template
- long life tool
- easy, one hand, operation
- simple and safe to use
- noise under limit
- low air consumption
- ideal for application in hazardous areas

Advantage of 19/3514-2:

- ideal for recycling companies, because of cutting through seams in barrels, also for cutting open lids in barrels, to empty the contents
- important, if contents are inflammable, Pneumatic Metal shear cuts without sparks
- serrated knife for better grip when cutting through painted or dirty material

Advantage of 19/3514-7R:

- cutting of a small radius, outside or inside
- ideal for inside cutting in spiral ducts, through the seams

Advantage of 19/3520:

- this cutting tool is ideal for cutting metal up to 2 mm, also through profiles and steel studs



Recycling of barrels 19/3514-2

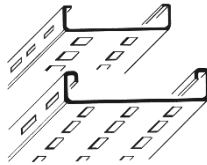

cut-outs from drilled starting hole 12-14mm



cutting of shaped parts

DRACO Metal Shears		19/ 3514-2	3514-7R	3520
max. cutting capacity	Art.no.:	62060-1	62070-1	62080-1
steel	400 N/mm ²	mm/ga. 2,0/14	2,0/14	2,0/14
stainl. steel	600 N/mm ²	mm/ga. 1,5/17	1,5/17	1,5/17
stainl. steel	800 N/mm ²	mm/ga. 1,3/18	1,3/18	1,3/18
aluminium	250 N/mm ²	mm/ga. 3,0/10	3,0/10	3,0/10
tightest radius	mm/ "	200/8	45/1¾	200/8
duct & Pittsburgh Seam	mm/ "	4x0,9	4x0,7	4x0,7
double lock seam 250N/mm ²	mm/ "	6x0,7		
working speed	m/min	9	9	9
strokes	min ⁻¹	3000	3000	3000
air-consumption at 6 bar/min.	m ³ ±	0,18	0,18	0,18
motor capacity	Watts	200	200	200
weight	kg	1,3	1,3	1,3
noise	db(A)	78	78	78

spare parts	19/3514-2	19/3514-7R	19/3520
knife	035141	371401	035201
set of jaws	BG35146	BG37222	BG35020
knife-pin set	BG35055	BG35055	BG35055

optional accessories	
support roller (plastic)	BG10076
support roller (metal)	BG10077
metal box	18000

all units are ready to use

BG=Set

12V



Cordless Shears and Nibblers System 3000 Ni-MH

Common features:

- ergonomic designed motor
- Power Plus motor: 30% more power
- long life battery packs 3,0 Ah highest quality
- cutting up to 150 meters with one battery charge
- universal charger RCA
- charger is suitable for charging all systems 3000 battery packs
- computer controlled pulse charging technology charges batteries quickly and gently, leading to a threefold increase in life of battery packs
- fail-safe polarity protection
- fully automatic functions: continuous temperature monitoring and switching from quick charge to trickle charge make overcharging impossible!
- LED control panel reports charging status or malfunction



Slitter Shear



Battery MXL 12 3.0Ah



Charger RC (230V/12V)



Transport box 42861

5-pcs. craftsmen-set consists of:

- 1 shear
- 1 charger RCA
- 2 batteries MXL
- 1 transportbox

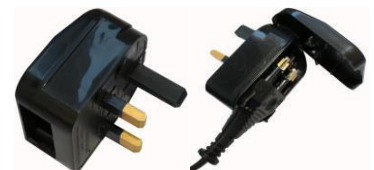

UK-Adapter (EU-GB) 341819

DRÄCO Cordless Ni-Cd Shears	AK 3010	AK 3013	AK 3016	AK 3520	AK 3514-2	AK 3514-7R
<i>Item number 5-pcs.craftsmen-set:</i>	30103	30133	30163	35203	351423	351473
max. cutting capacity						
steel 400 N/mm ² mm/ga.	1,0 / 19	1,3 / 18	1,6 / 17	2,0 / 14	2,0 / 14	2,0 / 14
stainl.steel 600 N/mm ² mm/ga.	0,7 / 21	1,0 / 19	1,3 / 18	1,3 / 18	1,3 / 18	1,3 / 18
stainl.steel 800 N/mm ² mm/ga.	0,4 / 25	0,7 / 21	1,0 / 19	1,0 / 19	1,0 / 19	1,0 / 19
non ferro 250 N/mm ² mm/ga.	1,5 / 17	2,0 / 14	2,5 / 12	2,5 / 12	2,5 / 12	2,5 / 12
tightest radius ±mm/ "	50 / 2	100 / 4	140 / 5½	200 / 8	200 / 8	45 / 1¾
working speed ±m/min	3,5	3,5	3,5	4	4	4
strokes ±min ⁻¹	1800	1800	1800	1800	1800	1800

operational field of the cordless shears: see the electric versions SD5-1, S1001N-1, 1016-1, 3520, 3514-2 & 3514-7R.

Note: Due to temperature and material, cutting capacity per battery charge can be over- or under the average.

all units are ready to use



Cordless System 3000 overview

AK 3010

- ideal for tin smiths and roofers
- accurate curve and burr-free cutting
- knife and jaws can be re-sharpened and exchanged
- shear head equivalent to SD5-1



AK 3013 and AK 3016

- ideal for site work
- burr-free cutting
- shear blade head with re-grind able and exchangeable blades
- shear heads equivalent to S1001N-1 resp. 1016-1



AK 3520

- ideal for all shop installation, for example: cutting cable trays, steel studs
- knife and jaws can be re-sharpened and exchanged
- shear head equivalent to 3520



AK 3514-2 & AK 3514-7R

- spiral ducting
- roof & wall claddings
- through seams 6 times folded
- mesh and wire
- shear head AK 3514-2 equivalent to 3514-2
- shear head AK 3514-7R equivalent to 3514-7R



18V



Li-Ion Cordless Tools

18 Volt Power Unmatched Run-Time, Superior Durability

MD batteries last longer, think faster, and work harder than all other professional LITHIUM-ION batteries. Built to withstand the harshest environments, MD batteries deliver more work over the course of your day and over the life of the battery.

- 4-pole motors, featuring rare-earth magnets, provide more power, more run-time, and longer life than any competitor motor. This provides smaller, lighter, and more capable tools that last longer on the jobsite.
- the batteries provide up to 40% more run-time, 20% more power and 50% more recharges than conventional lithium-ion batteries. MD18 batteries deliver best in class performance in extreme job-site conditions, including temps as low as 0°F/-18°C. In regions where heat is also a critical factor, MD18 batteries operate 20% cooler than conventional lithium-ion batteries and offer fade free power with no memory effect.
- Fully compatible with M18™ cordless products currently available, the new MD18 battery packs provide an instant upgrade to the performance, run-time and durability of the M18™ tools you already own.
- cutting up to 200 meters with one battery charge



Shear



Battery 2.0 Ah
341820



Battery 4.0 Ah
341840



Charger CLi EU
341810



Transport box 42861

5-pcs. craftsmen-set consisting of:

- 1 shear (without batt.)
- 1 charger CLi (30 Min.)
- 2 batteries (2.0 Ah + 4.0 Ah)
- 1 transport box

DRACO Cordless Li-Ion Slitter Metal Shears	AK 3010 Li-Ion	AK 3013 Li-Ion	AK 3016 Li-Ion	AK 3515 Li-Ion	AK 3520 Li-Ion	AK 3514-2 Li-Ion	AK 3514-7R Li-Ion
<i>Item number 5-pcs.craftsmen-set:</i>	630003	630103	630163	630633	630603	630703	630803
max. cutting capacity							
steel 400 N/mm ² mm/ga	1,0 / 19	1,3 / 18	1,7 / 16	2,0 / 14	2,0 / 14	2,0 / 14	2,0 / 14
stainl.steel 600 N/mm ² mm/ga	0,7 / 21	1,0 / 19	1,3 / 18	1,5 / 15	1,5 / 15	1,5 / 15	1,5 / 15
stainl.steel 800 N/mm ² mm/ga	0,5 / 24	0,7 / 21	1,0 / 19	1,3 / 18	1,3 / 18	1,3 / 18	1,3 / 18
non ferro 250 N/mm ² mm/ga	1,5 / 16	2,0 / 14	2,5 / 13	3,0 / 11	3,0 / 11	3,0 / 11	3,0 / 11
duct seam 400 N/mm ² mm	-	-	-	-	-	4 x 0,90	4 x 0,75
roof seam 250 N/mm ² mm	-	-	-	-	-	6 x 0,75	-
tightest radius ± mm/ "	50 / 2	100 / 4	140 / 5½	200 / 8	200 / 8	200 / 8	45 / 1 ¾
working speed ± m/min	4	4	4	4	5	5	5
strokes ± min ⁻¹	1800	1800	1800	1800	1800	1800	1800

operational field of the cordless shears: see the electric versions SD5-1, S1001N-1, 1016-1, 3520, 3514-2 & 3514-7R.

DRACO Li-Ion Slitter Plastic Shears	AK 3000 Li-Ion HDPE Pipe Slitter	AK 3550 Li-Ion Plastic Shear
<i>Item number 5-pcs.craftsmen-set:</i>	633303	633203
max. cutting capacity		
HDPE ± mm	6	3,5
PVC, ABS, PP, etc. ± mm	3,5	3,5
Polyester Formica ± mm	3,0	3,0
Hardboard ± mm	5	5
tightest radius ± mm	250	175
working speed ± m/min	1-4	1-4
strokes ± min ⁻¹	1800	1800

operational field of the cordless shears: see the electric versions 3500, 3550.



UK-Adapter (EU-GB)
341819





Li-Ion Cordless Tools Overview Slitter Shears



Metal Shear AK 3010 Li-Ion

- ideal for tin smiths and roofers
- accurate curve and burr-free cutting
- knife and jaws can be re-sharpened and exchanged (shear head equivalent to SD5-1)

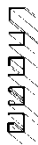

Metal Shear AK 3013 Li-Ion

- ideal for site work
- burr-free cutting
- knife and jaws can be re-sharpened and exchanged (shear head equivalent to S1001N-1)



Metal Shear AK 3016 Li-Ion

- ideal for site work
- burr-free cutting
- knife and jaws can be re-sharpened and exchanged (shear head equivalent to 1016-1)



Seam Metal Shear AK 3514-2 Li-Ion

- spiral ducting
- roof & wall claddings
- through seams 6 times folded
- mesh and wire (shear head equivalent to 3514-2)



Seam Metal Shear AK 3514-7R Li-Ion (radius)

- spiral ducting
- cut outs in Spiro tubes, very good curve ability (shear head equivalent to 3514-7R)



Metal Stud Shear AK 3515 Li-Ion

- perfectly adapted to the needs of dry wall companies. **Cuts C-, CW- and even UA-profiles!** (shear head equivalent to 3515)



Profile Metal Shear AK 3520 Li-Ion

- ideal for all shop installation, example: cutting cable trays, steel studs
- knife and jaws can be re-sharpened and exchanged (shear head equivalent to 3520)

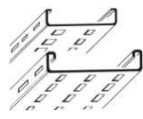





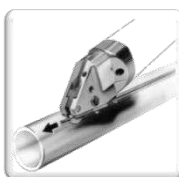





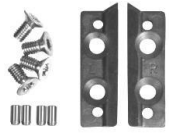
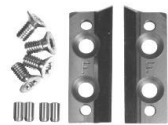



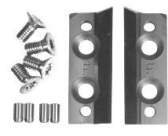



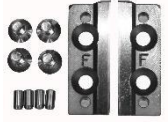



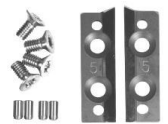

Pipe Slitter Plastic Shear AK 3000 Li-Ion







- perfect tool to slit HDPE-pipes and plastic tanks (shear head equivalent to 3500)









Overview of the wear parts slitting shears







Art.No.:	Description		Label	Art.No.:	Description		Label
01001	Knife for 1001, S1001N(-1)		1001	035141	Knife for 3514-2		3514-2
BG10600	Set of jaws assembly group for Typ1, 1001, S1001N(-1)		L R	BG35146	Set of jaws assembly group for 2020, 3514-2, 3515, 1020-1		F F
01011	Knife for SD5		SD5	035151	Knife for 3515		3515
BG13574/1	Set of jaws assembly group for SD5(-1), Typ1-SD5		L ● R ●	BG35146	Set of jaws assembly group for 2020, 3514-2, 3515, 1020-1		F F
01013	Knife for 1013, 1016-1, 2017		1013	035201	Knife for 3520		3520
BG13074	Set of jaws assembly group for 1013, 1016-1			BG35020	Set of jaws assembly group for 3520		F F without points
BG20234	Set of jaws assembly group for 2017		4 4	07014	Knife for UVS-1		1014 S
010135	Knife for 1013-5, 2020, 1020-1		1013/5	BG13574	Set of jaws assembly group for 1013-5		5 5
BG13574	Set of jaws assembly group for 1013-5		5 5	30068	Knife for 3500		1014
BG35146	Set of jaws assembly group for 2020, 3514-2, 3515, 1020-1		F F	BG30074	Set of jaws assembly group for 3500		5 5
371401S7	Knife for SD7-1		2020-7R	10110	Pattern Knife for different shears, extremely maneuverable		1011
371401	Knife for 3514-7R		3514-7R	01002	Knife for Plastic Shears		1002
BG37222	Set of jaws assembly group for SD7-1, 3514-7R		R R or 7 7	BG20600	Set of jaws assembly group for 1002, S1002N(-1)		L R
				BG20601	Set of jaws assembly group for 3550		

Other parts slitting shears

Art.No.:	Description	
10007	Gear for SD5(-1), S1001N(-1), S1002N(-1), UVS(-1)	
10004	Eccentric Shaft for SD5(-1), S1001N(-1) 1016-1	
BG10004	Assemble Group Eccentric Shaft for SD5(-1), S1001N(-1)	
BG35556	Assemble Group Eccentric Shaft for 3514-2, 3514-7R, 3520	
10250	Ball Bearing for SD5(-1), S1001N(-1) 1016-1, 1013, 1013-5, 2017, 2020, 1020-1	
BG12555	Knife Pin Set for SD5(-1), S1001N(-1), 1016-1, 1013, 1013-5 S1002N(-1), UVS(-1)	

Art.No.:	Description	
BG20065	Set of Guiding Blocks for Plastic Shears S1002N(-1), 3550. Corrugated Materials	
10005	Inner Ring for all DRÄCO Metal- & Plastic Shears	
BG12400	Set of Shims for all DRÄCO Metal- & Plastic Shears	
11300 M4x8	Torx-Screws M4x8 for Jaws / Pc.	
11400 M3x8	Torx-Screws M3x8 for Spring Plate / Pc.	
BG35149	Knife Pin Set for 2017, 2020, 1020-1, 2020-7R, SD7-1	
BG35155	Knife Pin Set for Series 35: 3514-2, 3514-7R, 3515, 3520	

Overview of the wear parts nibblers

Art.No.:	Description	
12130002	Punch for 1213(-1)	
12130003	Die for 1213(-1)	
12160002	Punch for 1216(-1)	
12160003	Die for 1216(-1)	
12160102	Punch for Profile Set 160	
41577	Die for Profile Set	

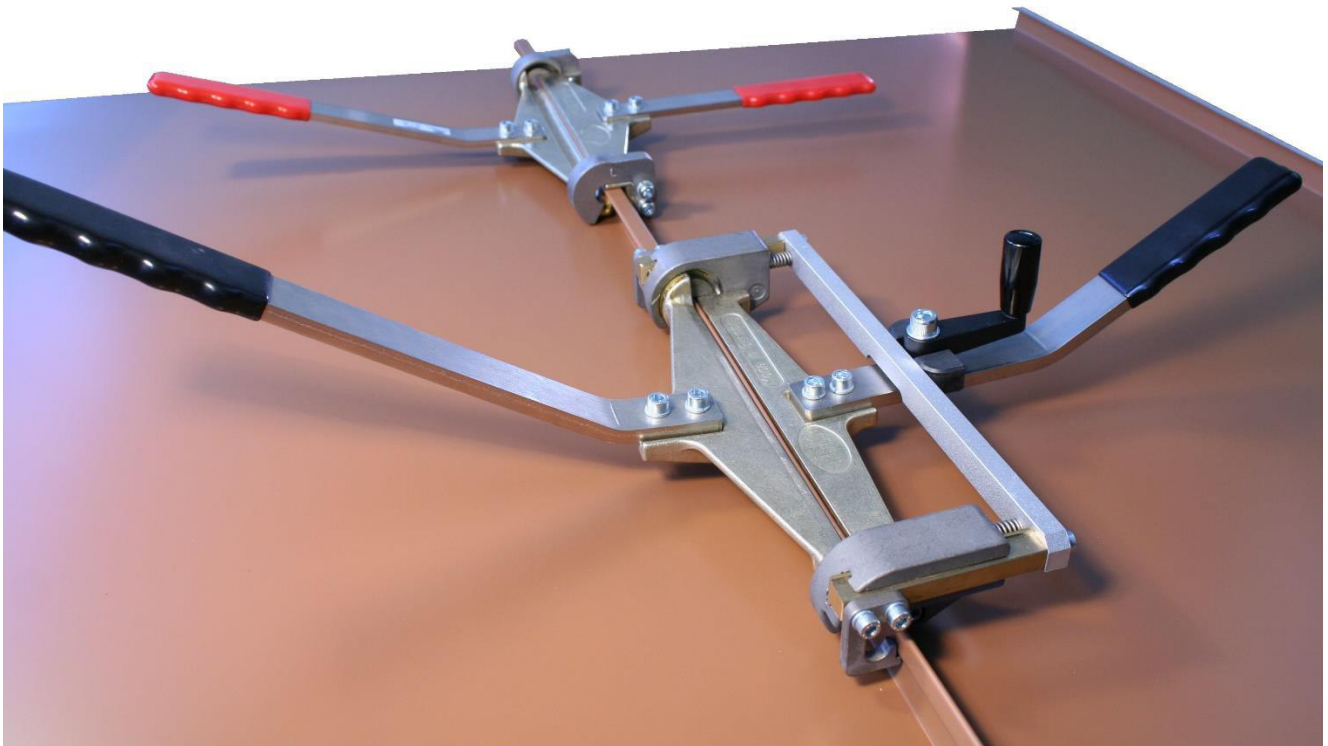

The roof and wall program

DRÄCO, partner of trade, commerce and industry founded in 1951. In 1989, the production of DRÄCO power tools and metal shears was supplemented by standing seam program K-series. Many novelties, innovations and user requirements have been implemented by us. Many DRÄCO innovations make secure and time-saving in the use of our equipment. Consider for example the patented duo function switch K9-1-DF of our power seamer K9-1, offering maximum safety and comfort.

At the beginning of the development there was the innovative profiling line K1. An industrial manufacturing roll forming system with free-running profile rollers was presented for the first time.

Also in the field of manual seaming, we break new ground. First there's the hand former K7 for the double lock seam, which clings tightly to the single seam and closes the double lock seam so comfortably without requiring the entire "body usage" of the roofer. Just like

its little brother, the angle seam hand former K8, the double folding hand former K7 is made from non-rusting materials and also useable for stainless steel. The roll forming machines are complemented by the arch bending machine PROFI FORM. The light and mobile segmented detail finger brake K1-AGNU-3, bends down and to the top. Hereby, the clean production of cassettes, eaves and much more is child's play.

More members of the standing seam family are the hand former K5 for arches and dormers and the angle seam hand former K8N. This hand formers close the seam, due to their interesting and novel design, very tight.

The wide range of production was added by the versatile DRÄCO-Bender family in 2010. Inexpensive, combinable, extensible, efficient helpers on the construction site.

Power Seamer K9-1-GWS metal-case included
for walls, façades, domes & barrel-vaulted roofs

Art. No.:	91580-1	2 Stations	kg
	K9-1-GWS	230V/1150W	16

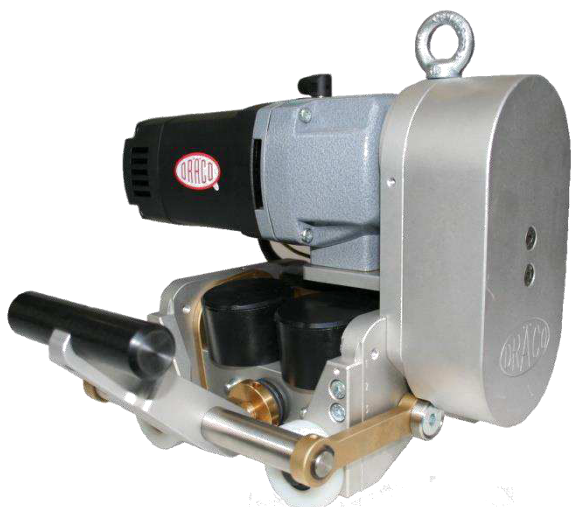

K9-1-GWS



- **switch for forward and reverse** allows running up and down the seam for one-man operation
- less time, less labour
- no unnecessary ways
- time saving

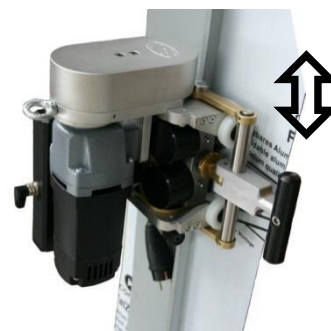

Two forming stations for single lock seam on walls, façades & barrel curved roofs.

- sheet metal, aluminium, copper, zinc (weathered or coated) up to 0,8 mm, stainless steel up to 0,5 mm
- ideal for barrel curved roofs, down to minimum radius of 60 cm
- adjustable for seam heights 25-60 mm
- pressure adjustment K9-1-ASS to achieve an optimum closed seam
- working speed 5,5-13 m/min. up and down the wall and on the roof
- light weight, only 16 kg
- optional remote control



Remote Control K9-1-KF

As an option, the remote control K9-1-KF can be assembled to the seamer. This remote control is ideal to close a panel on the facade or wall, convenient from the ground. It can be used on top of the roof to close barrel curved or vaulted panels. Due to the remote control for forward, stop and reverse operation, the operator can back up the seamer to the starting point, without to proceed to the machine.

Options:		Art. No.:
■ Dual-Safety Switch (stops the machine automatically)	K9-1-DF	91605-1
■ Remote Control 12 meter	K9-1-KF	91660-12
■ Remote Control 18 meter	K9-1-KF	91660-18
■ Remote Control 25 meter	K9-1-KF	91660-25
■ Winterset adjustable 230V/3000W, 650°C, 550l/min.	K9-1-WS	91640-1

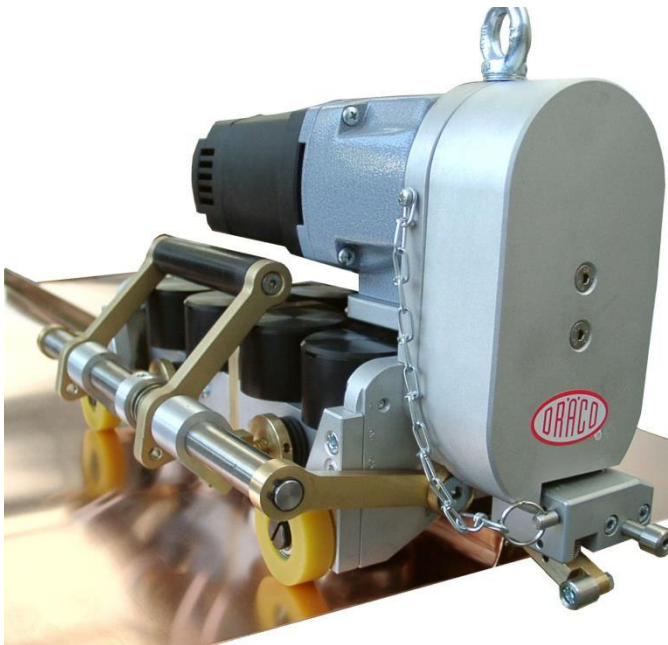

K9-1 with dual-safety switch K9-1-DF

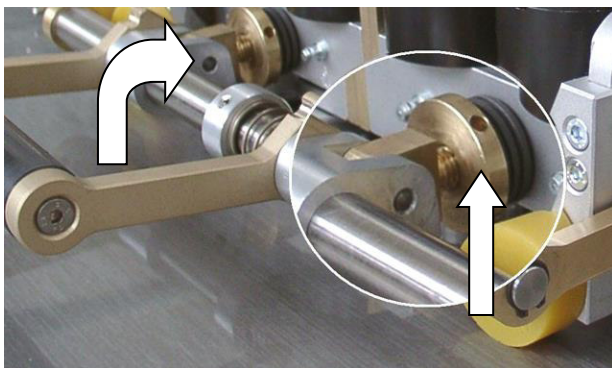

- variable pressure adjustment K9-ASS to achieve an optimum closed seam
- locking handle moveable, down or up away from obstructions as windows, chimneys,

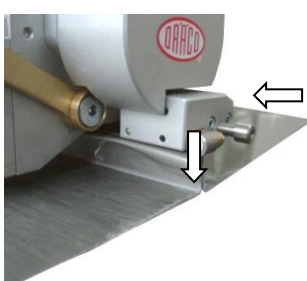

the patented DUAL-Safety-Switch K9-1-DF stops the K9-1 automatically at the end of a seam, wall or obstruction.

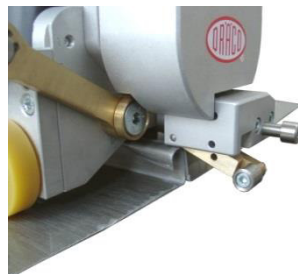

Technical improvements can be changed without prior notice

Automatic Power Seamer K9-1 including metal-case Profile Heights 25 mm - 60 mm (1" – 2½")

Power Seamer K9-1-WAD is a new combination of DRACO patented functions all together. New is the variable speed control to close panels in summer or in wintertime (ideal in combination with the Winter Set, especially at low outside temperatures). The K9-1 can be used for forward and reverse operation, in combination with the dual safety switch, which stops the machine automatically, at the end of the panel or against an obstruction. SAFETY FIRST ON SITE IS OUR ENDEAVOUR. A remote control for forward and reverse is available, to close panels at the façade or wall as an optimal extra.

	Art. No.:	115 or 230 V / 1150 W	kg ±
K9-1	91560-1	230 Volt double lock	21
K9-1	91561-1	115 Volt double lock	21
K9-1-WAD	91565-1	230 Volt compl.version*	22
K9-1-WAD	91566-1	115 Volt compl.version*	22

* including set of forming rolls f. single seam K9-1-WR, set of cutting rolls K9-1-AR, dual-safety-switch K9-1-DF, variable pressure adjustment K9-1-ASS, variable speed control. See options on page 36 also.

- for double lock seaming in one pass
- two additional rolls K9-1-WR for single lock seaming
- sheet metal, aluminium, copper, zinc weathered or coated up to 0,8 mm; stainless steel up to 0,5 mm
- clean transition at cross seams by using variable pressure adjustment K9-1-ASS
- working speed 5,5 - 13 m/min. up the wall and on the roof
- maintenance-free, safe operation
- no damage to painted or coated sheets
- can be used or removed in the middle of a seam (preliminary hand-seaming required)
- accessory: dual safety switch for safe operation at the wall and roof. The Power Seamer stops automatically at the end of the seam, against a wall or obstruction
- barrel curved roofs can be seamed using single or double lock system to the minimum radius 1,2 m
- seam cutting can be accomplished by using cutting rolls K9-1-AR for roof and wall renovation and repairs

Set of cutting rolls K9-1-AR



K9-1-AR Cutting rolls ideal for roof, wall and façade renovation or repair through wind or hail destruction. No damage to roof deck. Indispensable for fast and safe dismantling, of double lock and standing seam. Cutting speed 5 to 9 m/min.



Cutting the seam with the clips leaving an up stand of 8 mm (1). Dismantling of the panel from roof or wall without any difficulty. Advantage no burr and an up stand of 8 mm on both sides. Remaining 8 mm can be bend up 25 mm for the under cloak (2) Profiling a wider panel with the over cloak on both sides (3) fit the clips to the under cloak and lay wider panel on top of the under cloak (4). Close the seam both sides with the Power Seamer K9-1(5).

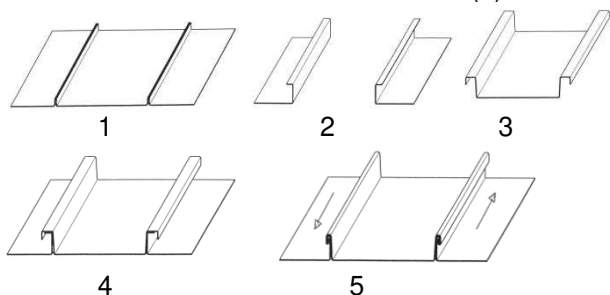

REMOTE CONTROL (optional) K9-1-KF with forward and reverse operation.

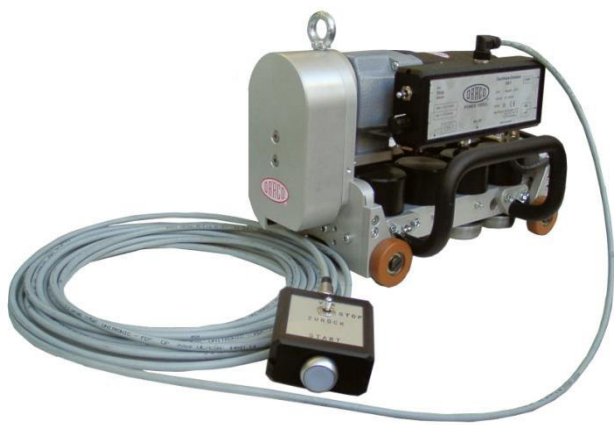

Multifunctional by various accessories:		Art. No:
■ set of forming rolls f. single seam	K9-1-WR	91620-1
■ set of cutting rolls	K9-1-AR	BG91625-1
■ dual-safety-switch	K9-1-DF	91605-1
■ variable pressure adjustment	K9-1-ASS	91610-1
■ remote control	K9-1-KF	91660-1
■ winter set, heat control, 3000W, 650°C, 550l/min.	K9-1-WS	91640-1

* included in complete set K9-1-WAD

Low temperatures

Material as zinc should not be processed under +10°C/+50°F. For trouble free seaming Winter Set K9-1-WS, attached to the Seamer using speed control in low working speed is ideal for best result in low temperatures.

Due to a low working speed and the winter set on high temperature (650°C / 1202°F) it is possible to close seams professional in cold temperatures.

K9-1 with Winterset K9-1-WS

With the help of the winter set, especially Zinc or all other materials can be seamed in cold temperatures.

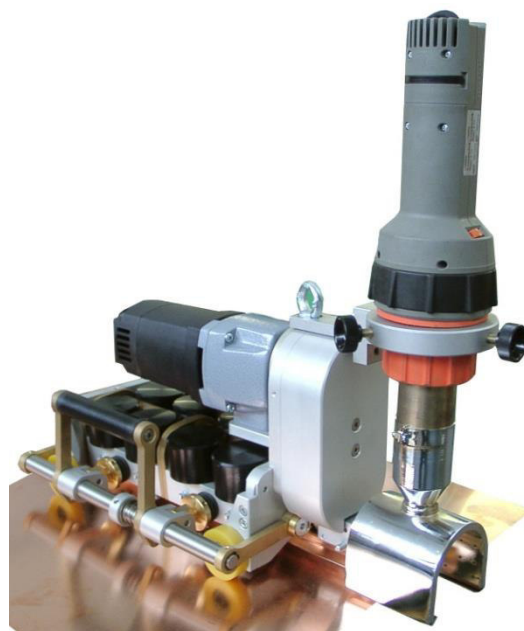

K9-1 with Winterset K9-1-WS

Power Seamer K9-1-ERB incl. metal case
for different Round Profiles
Profile Heights 48 mm - 65 mm ($\pm 1.9''$ - 2.5'')

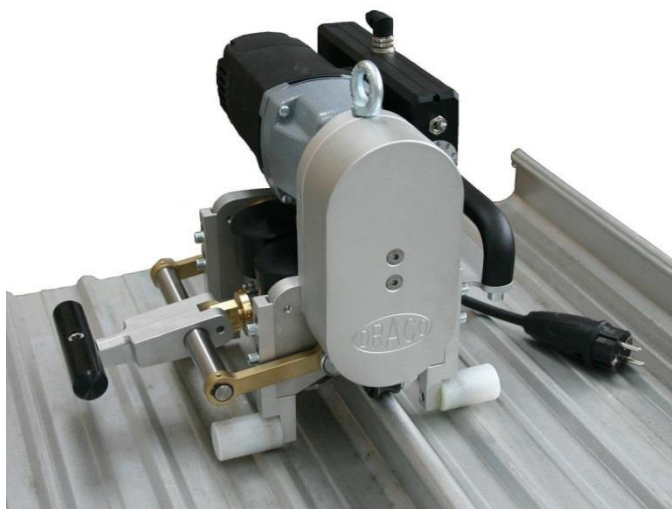

K9-1-ERB

Useable for straight, conical, convex or concave rounded profiles

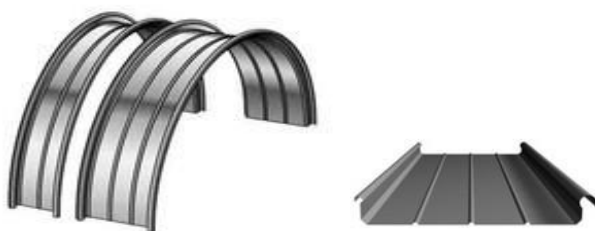

Item:	Art. No.:	1150 W	Kg \pm
K9-1-ERB	91592	230V / for round profiles	16
K9-1-ERB	91595	115 V/ for round profiles	16

inclusive fold opening roll and metal case

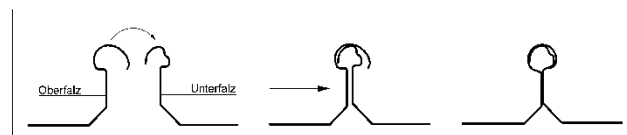

Increasingly Tinsmith specialized companies, engage themselves with the assembling of self-feeding Roof Profile Panels. Specially to close the seam of industrial manufactured profiles, DRACO developed a multilaterally, usable Power Seamer K9-1 ERB. The machine can close straight, tapered, convex or concave Profiles of many manufacturers. The seamer has an ingenious pressure adjustment. The pressure can be adjusted variable, to achieve an optimum closed seam. Working speed of the machine is variable, from 9-18 m/min, whereby a remote control (as an option) can be assembled to the machine, especially for working on a steep roof or vertical wall.

The Power Seamer K9-1-ERB can be used to close round profiles in forward or backward motion.

For example:

Round profile nominal diameter closed: 20 mm,
minimum panel width: from 230 mm and 48-65 mm profile height of all current suppliers. Supporting legs are adjustable.

- No damage to painted or coated sheets.
- **For profile heights from 48 - 65 mm.**
- Variable working speed: 9 -18 m/min.
- Clean transitions at the clips, due to disc - spring-washer technology (aligns itself on thicker materials).
- Variable pressure adjustment K9-1-ASS for an optimum seam.
- Barrel shaped – or vaulted roofs, a radius from 2,0 meter and up can be closed.
- Can be used in the middle or removed from the seam.
- To dismantle for restoration, repair, or to open up a seam, use the Fold Opening Roll K9-1-ERB-AR.
- As an option, Remote Control K9-1-KF, for forward-stop-reverse operation.

Fold opening roll K9-1-ERB-AR

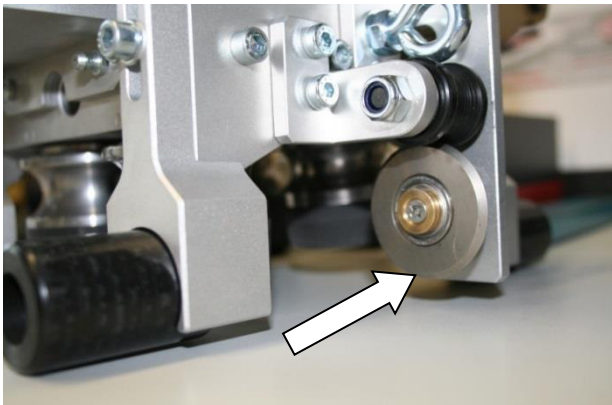

Fold opening roll K9-1-ERB-AR, irredeemable for dismantling a roof or single panels.

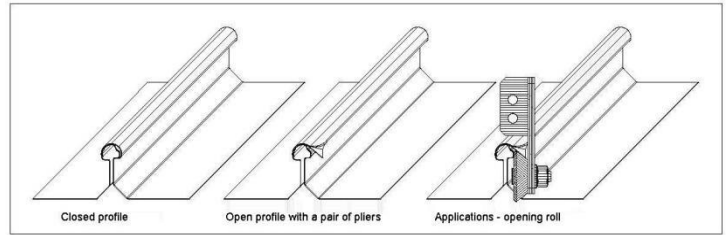

For forward-stop-reverse operation, with or without remote control K9-1-KF

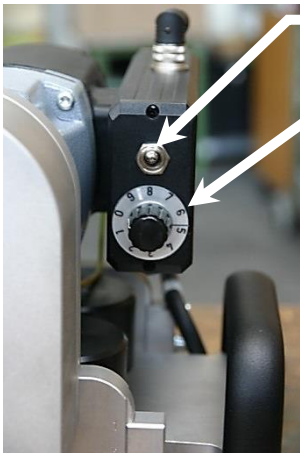

Switch for forward and reverse operation.

Variable Speed Control

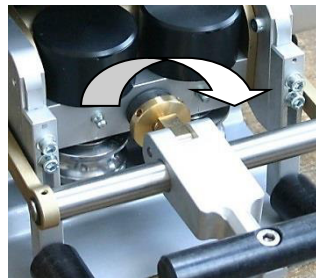

Variable Pressure Adjustment K9-1-ERB-ASS



K9-1-ERB with Remote Control K9-1-KF

Item:	Art. No.:	Description	Length
K9-1-KF	91660-12	Remote control	12m
K9-1-KF	91660-18	Remote control	18m
K9-1-KF	91660-25	Remote control	25m

As an option, the remote control K9-1KF can be assembled to the seamer. This remote control is ideal to close a panel on the facade or wall, convenient from the ground. It can be used on top of the roof to close barrel curved or vaulted panels. Due to the remote control for forward, stop and reverse operation, the operator can back up the seamer to the starting point, without to proceed to the machine.

In the reverse operation, automatically the dead man's handle is activated. Therefore, the START-Button must always be pressed in the reverse operation to activate the machine. This is for safety reasons.

Hand Seamer for round profiles

Art. No.:		L mm	kg	
HWRA140	To close round seams	220	2,6	1

Hand Seamer RA 140 or RA 141 is ideal for starting, at the end or for fixing the roof panel and areas with difficult access.

Hand Seamer for round profiles standing*

Art. No.:		L mm	kg	
HWRA141	To close round seams	220	3,8	1

*standing tool

All machines and tools in this catalogue can be changed for improvement, without prior notice.



RA140



RA141*



Hand Seamers

Single Lock Hand Seamer K 8

Ideal for starting seam, for short façades and areas with difficult access or an entire roof or wall

- no damage to coated or painted material
- easy to use
- minimal force required
- all parts are made of rust-free materials
- ideal for canopy roofs and many other applications



Material thickness:

aluminium, copper, zinc mm/ga. **0,8 / 21**
 steel, coated or painted mm/ga. **0,8 / 21**
 stainless steel mm/ga. **0,5 / 24**

Art.no.:	closing length	L mm	width mm	kg
91520	210 mm	255	270-570	2,3

Double Lock Hand Seamer K 7

This double lock hand tool is used after the single lock is closed. Ideal for starting and ending or continuous double lock seaming

- no marks on painted or coated profiles due to special hook locators
- quick, effortless folding
- all parts are rust-free and interchangeable
- easy to use



Material thickness:

aluminium, copper, zinc mm/ga. **0,8 / 21**
 steel, coated or painted mm/ga. **0,8 / 21**
 stainless steel mm/ga. **0,5 / 24**

Art.no.:	closing length	L mm	width mm	kg
91515-1	210 mm	310	320-610	3,3

Drip Edge Bender K 11 (eaves edger)

- to make a clean bend at drip edges without leaving marks.
- bends over 90° because of its wide opening
- it is also possible to bend a flat-seamed standing seam around and under the drip edge

Art.no.:	closing length	L mm	width mm	kg
91551	250 mm	240	250	1,7

Drip Edge Seamer K 12 (eaves sheet jaws)

- follow up tool to the drip edge bender
- permits a clean and fast locking of the drip edge

Art.no.:	closing length	L mm	width mm	kg
91552	200 mm	390	200	2



K8



K7



K11



K12

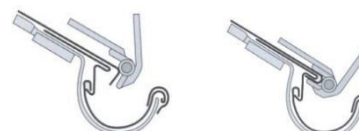

Single Lock Hand Seamer K 8 N & K 8 NL

A unique design for closing a single lock seam. This standard tool can be delivered in different lengths.

- no scratch marks to coated or painted material
- light in weight
- ideal for starting or at the end of the seam
- easy to use
- minimal force required
- the tool can be used for closing vertical and horizontal seams
- all parts are made of rust-free materials
- anodized for hardness

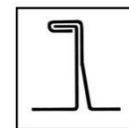

K 8 & K 8 NL

Material thickness:

aluminium, copper, zinc mm/ga. 0,8 / 21
 steel, coated or painted mm/ga. 0,8 / 21
 stainless steel mm/ga. 0,5 / 24

Art. no.:	closing length mm	length mm	width mm	kg
K8N : 91530	200	250	260-430	2,1
K8NL : 91535	350	400	310-530	3,1

Single Lock Hand Seamer K 5 for arches, domes & barrel-vaulted roofs

The Hand Seamer K 5, fast closing of profiled panels for arches, domes, dormers and barrel-vaulted roofs.

- no scratch marks to coated or painted materials
- light in weight
- easy to use
- minimal force required
- cleat and panel closing for wind uplift
- can be used for closing vertical and horizontal seams
- all parts are made of rust-free materials
- anodized for hardness

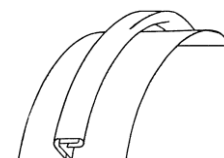
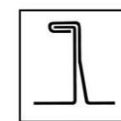

K5

Material thickness:

Similar to K8N and K8NL

Art. no.:	closing length mm	length mm	width mm	kg
91505	70	120	260-430	1,0

Batten Hand Seamer K 6-1 new model

Batten cap systems not only contribute to the architectural design of the roof but are highly functional and one of the oldest roofing systems still in use. Without any tools, the Hand Seamer K 6 is adjustable for batten T-caps from 45-65 mm and is suitable for materials up to 0,8 mm in thickness.

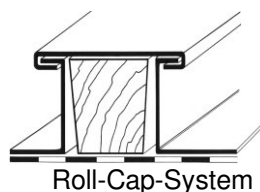

Roll-Cap-System



K6-1

Material thickness: Like K8N and K8NL

Art. no.:	closing length mm	length mm	width mm	kg
91510-1	210	280	45-65	3

0°- 90°



**Bending-Bevel-Tools
EcO-Benders**

Bending Material fast and perfect.
On site or in the workshop.

EcO-Bender3 – Your efficient little helper on site
Light weighted, with 4 guide rollers
and removable ergonomic Grip Handle

- EcO = **E**conomic with an **O**-formed Grip Handle
- 3 = three optimum ergonomic grip positions
- universal mobile Bending Tool, to bend and form all kind of materials, straight, concave or convex
- solves many technical bending problems, as up-stands and counter forms without any scratch mark
- the only Bender on the market today with an ergonomic O-grip system, offers a convenience good grip, even when the entire length is extended to 200 mm, (8 inch)
- eyelet to hang up the tool
- graduation in Inch and Millimetre

Technical Data:

Aluminium, Copper, Zinc	mm	1,0 (19 ga.)
Steel	mm	0,7 (22 ga.)
Stainless Steel	mm	0,5 (25 ga.)

Art.no.:	0°- 90°	Bend. height	kg
91545	complete with O-handle	5 – 200 mm	1,8
91545S1	without O-handle	5 – 200 mm	1,5
91545S3	complete with O-handle	5 – 350 mm	2,2
91545S4	without O-handle	5 – 350 mm	1,9
91549	Adapter to connect 2 EcO-Bender 200		1,5
91549S3	Adapter to connect 2 EcO-Bender 350		1,8
KH70400	O-handle for EcO-Bender and Mini-Bender		0,3



Adapters 91549 & 91549S3



O-handle KH70400

Mini-Bender3 and Duo-Mini-Bender3
With each 2 guiding rolls

0°- 90°

- for continuous bending long materials.
- with the aid of an adapter 2 Mini-Benders can be assembled to a longer tool and disassembled again, to use two benders separately
- light in weight, small in size and price
- eyelet to hang up the tool
- graduation in Inch and Millimetre

Technical Data:

Aluminium, Copper, Zinc	mm	1,0 (19 gauge)
Steel	mm	0,7 (21 gauge)
Stainless Steel	mm	0,5 (25 gauge)

Art.no.:	0°- 90°	Bend. height	kg
91544	Mini-Bender3, 2 guide rollers	5 – 200 mm	1,4
91544S3	Mini-Bender3, 2 guide rollers	5 – 350 mm	2,0
91546	Duo-Mini-Bender 2x2 rollers	5 – 200 mm	3,4
91546S3	Duo-Mini-Bender 2x2 rollers	5 – 350 mm	4,5
91548	Adapter to connect 2 Mini-Benders		1,5



EcO-Bender3/200 mm #91545 / EcO-Bender3/350 mm #91545S3

3 optimum gripping positions and always good grip,
no matter how far the rod is pulled out:



Fabrication of Standing Seam Profiles:



[Video „how to fabricate standing seam panels“ available online!](#)



EcO-Bender3S1 91545S1 (200 mm, without O-handle)
EcO-Bender3S4 91545S4 (350 mm, without O-handle)

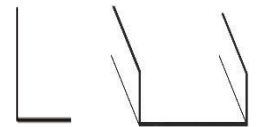

Mini-Benders

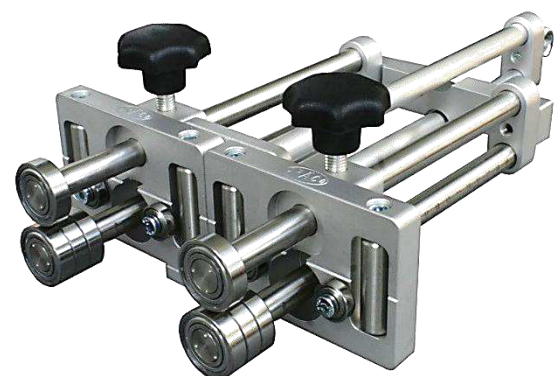

Duo-Mini-Bender3 200 91546 / Duo-Mini-Bender3 350 91546S3



Mini-Bender3 200 91544
Mini-Bender3 350 91544S3



Adapter 91548

0°-100°



**Bending-Bevel-Tools
EcO-Benders**

Bending Material fast and perfect.
On site or in the workshop.

EcO-Bender3 – Your efficient little helper on site
Light weighted, with 4 guide rollers
and removable ergonomic Grip Handle

- EcO = **E**conomic with an **O**-formed Grip Handle
- 3 = three optimum ergonomic grip positions
- universal mobile Bending Tool, to bend and form all kind of materials, straight, concave or convex
- solves many technical bending problems, as up-stands and counter forms without any scratch mark
- the only Bender on the market today with an ergonomic O-grip system, offers a convenience good grip, even when the entire length is extended to 200 mm, (8 inch)
- eyelet to hang up the tool
- graduation in Inch and Millimetre

Technical Data:

Aluminium, Copper, Zinc	mm	1,0 (19 ga.)
Steel	mm	0,7 (22 ga.)
Stainless Steel	mm	0,5 (25 ga.)

Art.nr.:	0°- 100°	Bend.height	kg
91545100	complete with O-handle	5 – 200 mm	1,8
91545100S1	without O-handle	5 – 200 mm	1,5
91541005S3	complete with O-handle	5 – 350 mm	2,2
91545100S4	without O-handle	5 – 350 mm	1,9
91549	Adapter to connect 2 EcO-Bender 200		
91549S3	Adapter to connect 2 EcO-Bender 350		
KH70400	O-handle for EcO- and Mini-Bender		0,3



Adapters 91549 & 91549S3

O-handle KH70400

Mini-Bender4 and Duo-Mini-Bender4
With each 2 guiding rolls

- for continuous bending long materials.
- with the aid of an adapter 2 Mini-Benders can be assembled to a longer tool and disassembled again, to use two benders separately
- light in weight, small in size and price
- eyelet to hang up the tool
- graduation in Inch and Millimetre

Technical Data:

Aluminium, Copper, Zinc	mm	1,0 (19 gauge)
Steel	mm	0,7 (21 gauge)
Stainless Steel	mm	0,5 (25 gauge)

Art.nr.:	0°- 90°	Bend. height	kg
91544100	Mini-Bender4, 2 guide rollers	5 – 200 mm	1,4
91544100S3	Mini-Bender4, 2 guide rollers	5 – 350 mm	2,0
91546100	Duo-Mini-Bender 2x2 rollers	5 – 200 mm	3,4
91546100S3	Duo-Mini-Bender 2x2 rollers	5 – 350 mm	4,5
91548	Adapter to connect 2 Mini-Benders		1,5

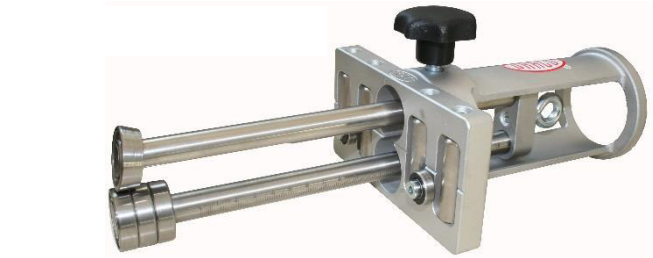

EcO-Bender4/200 mm 91545100 / EcO-Bender4/350 mm 91545100S3

3 optimale Greifpositionen und immer guten Halt, egal wie weit das Gestänge ausgezogen wird:



Fabrication of Standing Seam Profiles:

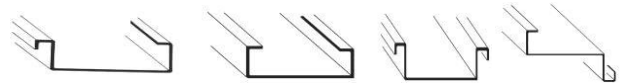

EcO-BenderS1 91545100S1 (200 mm, without O-handle)
EcO-BenderS4 91545100S4 (350 mm, without O-handle)



Mini-Benders

0°-100°

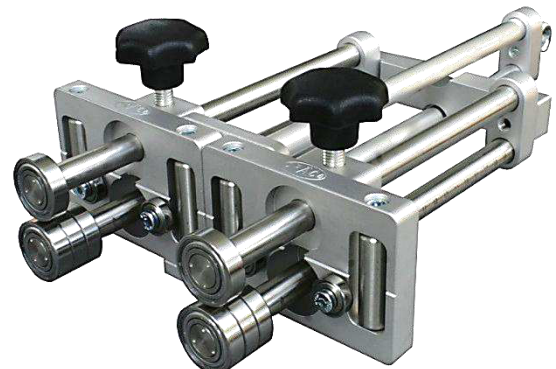

Duo-Mini-Bender4 200 91546100 / Duo-Mini-Bender 350 91546100S3



Mini-Bender4 200 91544100
Mini-Bender4 350 91544100S3



Adapter 91548

Vario-Bender VB 200

Variable thickness

like EcO-Bender3S1, but with an infinitely adjustable top roller to process thicker sheet metal

Universal and mobile bending and forming of metal

Art.no.:	0°- 90°		kg
91545S6	without O-handle		1,5
91549	Adapter to connect 2 EcO-Benders 200, or 2 Vario-Benders 200		1,5

Capacity:

Lead	mm	ca. 5,0
Aluminum, Copper, Zinc	mm	ca. 2,0
Steel 400 N/mm ²	mm	ca. 0,7
Stainl. Steel 600 N/mm ²	mm	ca. 0,5

Depending on user max. capacities might be different

Everyone knows this. You want to put material that is a bit thicker and it is not possible because the material does not fit between the rollers. You and the bender would be strong enough, but the material just does not fit. That is past tense. Now there is the new VARIO bender VB200. With the infinitely adjustable top roller to be able to put thicker plate up to 2.0 mm light metal.

Universal and mobile edging and forming of metal.
Manufacturing of various profiles, settings and counter settings.
Millimeter and inch indication, suspension eye for toolholder.
Handy, small in shape and price

0° - 90°

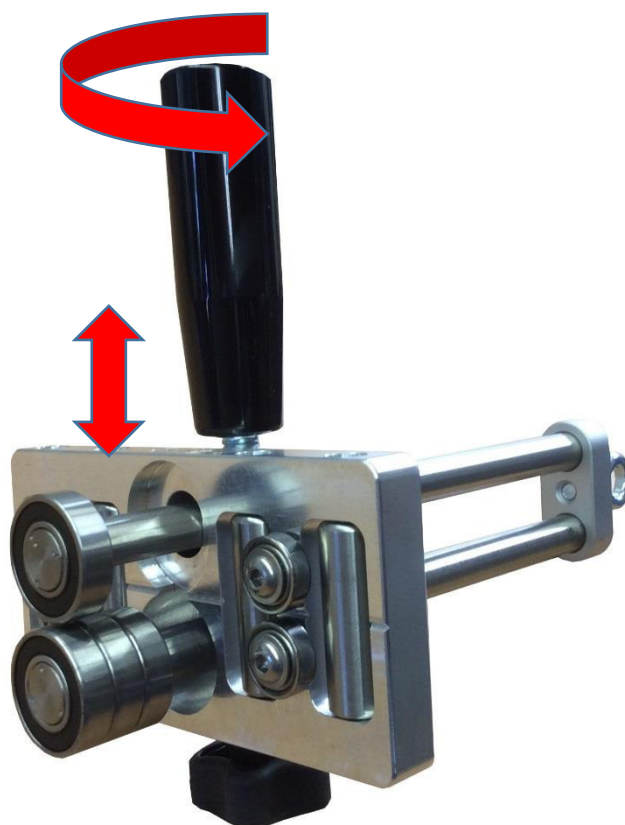

VARIO-Bender 200 # 91545S6



Adapter 91549

Supra-Bender

Supra-Bender

- to bend 0-120° from 30 mm up to 200/350mm
Enables overstretching to compensate for spring back of
E.g. stainless steel
- fabrication of drip edges, windowsills, eaves cladding,
valley construction and many more

Art.no.:	0°- 120°	Bending height	kg
91550	complete with O-handle	30 – 200 mm	2,0
91550S1	without O-handle	30 – 200 mm	1,8
91550S3	complete with O-handle	30 – 350 mm	2,4
91550S4	without O-handle	30 – 350 mm	2,1

0° - 120°





Bending-Bevel-Tools

Disc-Benders

Disc-Benders DB 41 & DB 42 Combi and DB 41 S2 & DB 42 S2 Combi (with swivelling wheel)

- a right angle of 90° can be bent to 180°
- no adjustment necessary
- for eaves cladding, cross seams, gutter flashings, valley channels, drip edges, wall capping and many more
- max. metal thickness up to 1 mm/19ga. (depending on material)

90°- 180°



Disc-Bender DB41 (single) 91541



Disc-Bender DB42 Combi (double) 91542. Ideal for long work pieces

NEW: DB41S2 & DB42S2 with swivelling wheel. Designed for placing the tool easily in work pieces that are difficult to access

Art.no.:	90°- 180°	Angle height	kg
91541	Disc-Bender DB 41	ca. 8 – 40 mm	0,9
91542	Disc-Bender DB 42	ca. 8 – 40 mm	2,6
91541S2	Disc-Bender DB41S2	ca. 8 – 40 mm	1,0
91542S2	Disc-Bender DB42S2	ca. 8 – 40 mm	2,7
91547	Adapter to connect 2 Disc-Benders		0,8



Adapter 91547



Disc-Bender DB41S2 (single) with swivelling wheel



Disc-Bender DB42S2 Combi 91542S2
Ideal for long work pieces.
Swivelling when single only.



Flange- & curve benders BKK 25 & BKK 50

- bends 0° - 90° ● light and handy
- ideal for curved work pieces and small radius
- max. sheet thicknesses up to 1 mm (material-dependent)
- smallest inner radius 40 mm at minimum heights
- graduation in Inch and Millimeter

0°- 90°

Art.no.:	0°- 90°	Bend. height	kg
91540	BKK 25	5 – 25 mm	0,8
91540S1	BKK 50	5 – 50 mm	0,9

Due to material characteristics data can be different. Bending height depends on radius. Radius depends on bending height.



BKK 25 91540

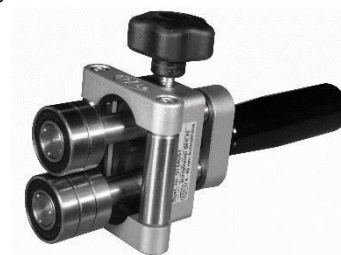
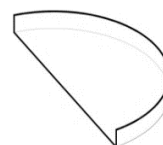

BKK 50 91540S1

Flange- & curve benders

SET2 EcO-Bender3/200 + Disc-Bender DB 41

- EcO-Bender3 0°-90° ■ Disc-Bender 90°-180°
- Tin man's gloves PERFECT FIT ■ Measuring tape 5m
- Tin man's pencil ■ Transport box

Art.no.:	0°- 180°		kg
91545SET2	91545 + 91541	incl. accessories	4,2

Applications see single tools

EcO-Bender3:



0°- 180°

EcO-Bender3: fabrication of stand seam profiles:



EcO-Bender3 + Disc-Bender:

Additionally and in combination it is possible to bend: Flashings, angular sheets with water seam, battens, sheets for verges, etc.



0°- 180° bending set 91545SET2

SET3 EcO-Bender3/200 + Disc-Bender DB 41 + Flange- & Curve Bender BKK 25

- EcO-Bender3 0°-90° ■ Disc-Bender 90°-180°
- Flange- and Curve Bender BKK 25 0°-90°
- Tin man's gloves PERFECT FIT ■ Measuring tape 5m
- Tin man's pencil ■ Transport box

Art.no.:	0°- 180°		kg
91545SET3	91545 + 91541 + 91540	incl. accessories	5

Applications see single tools

EcO-Bender3:



0°- 180°

EcO-Bender3: fabrication of stand seam profiles:

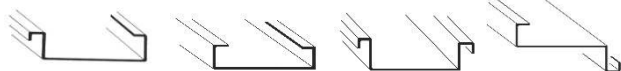

EcO-Bender3 + Disc-Bender:

Additionally and in combination it is possible to bend: Flashings, angular sheets with water seam, battens, sheets for verges, etc.:



0°- 180° bending set 91545SET3

BKK25: Flanges, round, straight, convex and concave

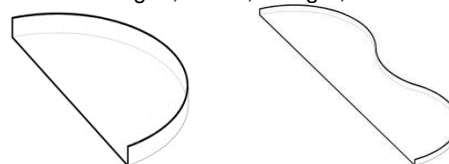

Would you prefer a different set combination?
Let us offer you your variant!

Beading and Bending Tool Multi-Bender 200

**Universal Tool for beading, offsetting, bending and trimming.
On site or in the workshop**

The multi Bender 200 is a lightweight, portable manual device. Ideal for the beading of sheet and folded or profiled material, as well as trimming.

The manual adjustment of the upper roller, as well as the sideways folding wings allow a delicate machining of the work pieces and the machining of complex shapes. The work piece is held not only by a stop plate, but also by vertically arranged hardened wheels and ball bearings which ensure the repeatability for recurring work pieces.

- free box for equipped tool
- interchangeable forming rolls
- beading or offset depth up to approx. 3,5 mm
- open guide rollers laterally to work on straight lines and bends more comfortable
- bend height: from 44 to 244 mm

Capacity, ca:

Aluminium, Copper, Zinc:	1,0 mm (18 ga.)
Steel	0,8 mm (20 ga.)
Stainless steel	0,5 mm (23 ga.)

*Subpages see available pair of rolls
Special pair of rolls on request*



Retractable lead wing for straight and round beads, or long and short bars



Multi-Bender 200 in case, 7 pair of rolls on, handle and guide

Multi-Bender 200 and accessories

Art.no.:	Type	Description	Picture	kg	lbs
91780	Multi-Bender 200	Basic Tool (without handle, without guidance device, without rollers)		2,1	4,4
91785	Handle	Helve		0,3	0,66
91786	Guidance device	Improves pushing & pulling		0,2	0,44









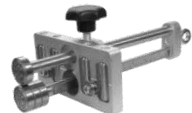

Multi-Bender- pairs or rollers

Art.nr.:	Type	Description	Picture	Sketch	kg	lbs
9179001	Pair of rolls #1	AS Offsetting 1			0,5	1,1
9179002	Pair of rolls #2	SF12 Flat beading 1/2", 12,5 mm			0,5	1,1
9179003	Pair of rolls #3	VS Offsetting 2			0,5	1,1
9179004	Pair of rolls #4	AB Setting / Bending			0,7	1,55
9179005	Pair of rolls #5	SRS Beading circularly (symmetric)			0,5	1,1











Multi-Bender- pairs or rollers

Art.nr.:	Type	Description	Picture	Sketch	kg	lbs
9179006	Pair of rolls # 6	SF25 Flat beading 1", 25 mm			0,5	1,1
9179007	Pair of rolls # 7	SRA Beading circularly (asymmetric)			0,5	1,1
9179008	Pair of rolls # 8	SV90 Beading V-shape 90°			0,5	1,1
9179009	Pair of rolls # 9	SV45 Beading V-shape 45°			0,5	1,1
9179010	Pair of rolls #10	SR Cutting rollers			0,5	1,1

Overview Bending Tools

Art.nr.:	Description	Facts	Picture
Uni-Bender			
91545 / 91545 100	EcO-Bender3/200 standard with O-handle	<ul style="list-style-type: none"> • O-handle • 4 guiding rollers • 5 – 200 mm bending • 0 - 90 ° / 0 - 100 ° 	
91545S1 / 91545 100S1	EcO-Bender3/200 special type without O-handle	<ul style="list-style-type: none"> • 4 guiding rollers • 5 – 200 mm bending • 0 - 90 ° / 0 - 100 ° 	
91545S3 / 91545 100S3	EcO-Bender3/350 special type with O-handle	<ul style="list-style-type: none"> • O-handle • 4 guiding rollers • 5 – 350 mm bending • 0 - 90 ° / 0 - 100 ° • 	
91545S4 / 91545 100S4	EcO-Bender3/350 special type without O-handle	<ul style="list-style-type: none"> • 4 guiding rollers • 5 – 350 mm bending • 0 - 90 ° / 0 - 100 ° 	
91544 / 91544 100	Mini-Bender 200	<ul style="list-style-type: none"> • 2 guiding rollers • 5 – 200 mm bending • 0 - 90 ° / 0 - 100 ° 	
91544S3 / 91544 100S3	Mini-Bender 350	<ul style="list-style-type: none"> • 2 guiding rollers • 5 – 350 mm bending • 0 - 90 ° / 0 - 100 ° 	
91550	Supra-Bender	<ul style="list-style-type: none"> • O-handle • 4 guiding rollers • 30 – 200 mm bending • 0 - 120 ° 	
Duo-Bender			
91546 / 91546 100	Duo-Mini-Bender 200	<ul style="list-style-type: none"> • 4 (2x2) guiding rollers • 5 – 200 mm bending • divisible into 2 individual devices • 0 - 90 ° / 0 - 100 ° 	
91546S3 / 91546 100S3	Duo-Mini-Bender 350	<ul style="list-style-type: none"> • 4 (2x2) guiding rollers • 5 – 350 mm bending • divisible into 2 individual devices • 0 - 90 ° / 0 - 100 ° 	
91543 / 91543 100	Duo-EcO-Bender 200	<ul style="list-style-type: none"> • 8 (2x4) guiding rollers • 5 – 200 mm bending • divisible into 2 individual devices • 0 - 90 ° / 0 - 100 ° 	
91543S3 / 91543 100S3	Duo-EcO-Bender 350	<ul style="list-style-type: none"> • 8 (2x4) guiding rollers • 5 – 350 mm bending • divisible into 2 individual devices • 0 - 90 ° / 0 - 100 ° 	
Art.No. *100* = 100°			

Overview Bending & Beading Tools

Art.nr.:	Description	Facts	Picture
Flange & curve benders 91540 91540S1	BKK 25	<ul style="list-style-type: none"> • 2 guiding rollers • 5 – 25 mm bending • good curve ability • 0 - 90 ° 	
	BKK 50	<ul style="list-style-type: none"> • 2 guiding rollers • 2 forming rollers above • 5 – 50 mm bending • good curve ability • 0 - 90 ° 	
Multi-Bender 91780/85/86 + 9179001 - 9179010	Multi-Bender 200 Beadng Offsetting Bending Trimming	<ul style="list-style-type: none"> • multifunctional bending & beading tool • 2 - 4 guiding rollers variable • 44 – 244 mm bending • good curve ability • 0 - 90 ° • Available rollers see pages 47+48 	
Disc-Bender 91541 91542	Disc-Bender (single)	<ul style="list-style-type: none"> • 8 – 40 mm • good curve ability • 90 - 180 ° 	
	Disc-Bender Combi (double)	<ul style="list-style-type: none"> • 8 – 40 mm • divisible into 2 individual devices • 90 - 180 ° 	
Adapter 91548 91548S3 91549 91549S3 91547	Adapter	Duo-Adapter for Mini Bender 200	
	Adapter	Duo-Adapter for Mini Bender 350	
	Adapter	Duo-Adapter for Eco-Bender 200	
	Adapter	Duo-Adapter for Eco-Bender 350	
	Adapter	Adapter incl. additional guidance for Disc-Bender Combi	

Combines 2 single Disc-Benders to 1 Disc-Bender Combi

All individual devices (except Multi-Bender and BKK) can be extended with the help of the adapter to duo devices.

Beading tool for Standing Seam Panels and sheets
Panel-Beader PB 250 Plus

Mobile Beading Tool for sheets and panels. Standing Seam Panels up to 38 mm and many other work pieces. On site or in the workshop.

The Panel Beader PB 200 Plus is a light, portable device with a manual drive. Ideal for beading sheet metal, coulters and folded or pre-profiled material. The manual feed of the top roller enables sensitive processing of the workpieces and the processing of complex shapes. The workpiece is not only guided through a stop plate, but also through vertically arranged hard guide rollers and ball bearings, which ensure the repeatability of recurring workpieces.

- Interchangeable form rollers
- Beading or offset depth up to approx. 3.5 mm
- Ideal for stiffening standing seam panels

Capacity, ca:

Aluminium, Copper, Zinc: **1,0 mm (18 ga.)**
 Steel **0,8 mm (20 ga.)**
 Stainless steel **0,5 mm (23 ga.)**

Special roller pairs on request

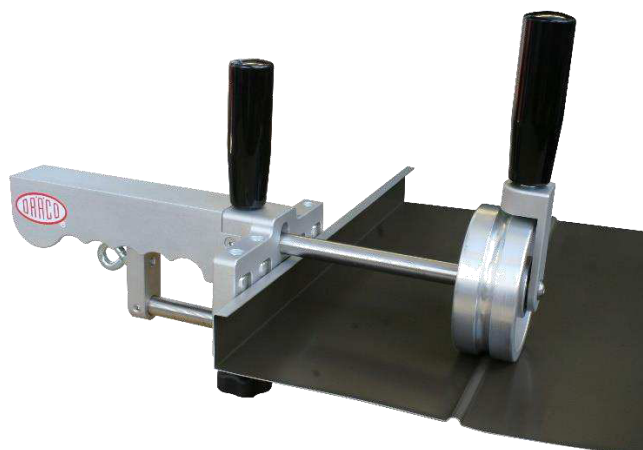

91900



Art.nr.:	Type	kg
91900	Panel Beader PB 250 Plus FLAT	ca. 3,2
91901	Panel Beader PB 250 Plus ROUND	ca. 3,2



91901

Detail Mobile Folding Brake K1-AGNU-3

	Item No.:	working width	kg
K1-AGNU-3	91292-3	1120 mm	80
K1-AGN-3*	91295-3	1120 mm	57

* without frame

Accessories:

1. Roller Shear K1-AGNRS-3 incl. guide
2. Guide 800 mm

K1-AGNRS-3	91267-3	Roller Shear	7
K1-AGNTA-3	91269-3	Depth Stop	3



K1-AGNU-3

K1-AGN-3



angle gauge



strengthened bending cheek



opt. depth stop 800 mm



opt. roller shear K1-AGNRS-3

Examples for bending metal to the top and down 180°

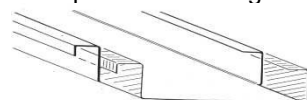

To bend fold to the top or down 180°, cut marked parts out the female and male panel

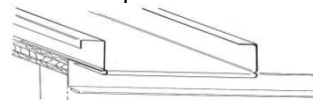

For connections at the gutter, ridge or wall, to the top or down 180°

Examples for flaps Pos. 1-6:

1. for flaps, cut marked parts out of female and male panel (under cloak, over cloak)
2. female and male 25 mm cut out (under cloak, over cloak)
3. with brake, bend 30° to top and bend flaps with a pair of pliers to the outside
4. bend fold 90° to top and press flaps with a pair of pliers tight
5. with a pair of seaming pliers bend flap to the right and left
6. press flaps tight with a pair of pliers

- ideal for roof and wall cladding
- solves all technical bending problems
- bends TOP and DOWN! See our Video!
- clamping of sheet metal with eccentrics and hand lever
- gas-pressure spring counterbalances top clamping bar
- bending possible in all technical directions for roof and wall claddings, see examples 1-6.
- brake can also be screwed on to a working bench
- brake removable from frame, for easy transport to the roof
- all parts used on the brake are made of rustproof materials

Technical data:

Opening of top clamping bar 60 mm
Aluminium, Copper, Lead, Zinc 0,8 mm,
Stainless Steel 0,5 mm

Standard-Equipment:

- segments for top clamping bar 560 / 202 R / 202 L / 102 / 127 / 76 / 52 mm
- assortment for bottom bending bar 1120 / 520 / 445 / 290 mm.
- frame with 4 castors (only K1-AGNU-3)
- Allen wrenches
- straight fence
- angle fence
- metal box (only K1-AGNU-3) for safe storage of parts and tools

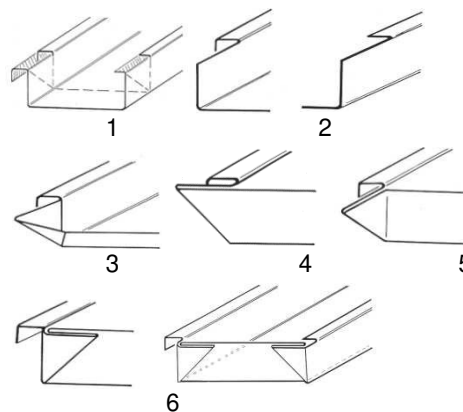

Instruction video:
www.dracotools.com



Pic.: K25-PQLB

- The PROFIMA - 25 is a fully mobile pan former ideal for both the workshop and for on-site operation.
- All functions and adjustments are positioned to one side of the machine. It is easy to transport, light weight with two castors mounted on frame. This saves on freight costs, shortages and the need for difficult leak prone panel end laps.
- The guillotine-shear K25-QMT cuts panels without distortion and burr-free.
- equipped with 4 crane lifting eyes.
- The PROFIMA K25-PRF or K25-PQLB produces standard 25 mm seam height panels in widths from 290 mm up to 800 mm plus tapered panels.

The DRACO name is known throughout the architectural metal panel industry for their innovation and superior quality.

Basic version K25-PRF/800:



Pan Former PROFIMA K 25

Art. No.:	91400 Basic version 230V	91450 Complete version* 230V
Art. No.:	91401 Basic version 115V	91451 Complete version* 115V
	K 25-PRF/800	K 25-PQLB/800

Technical Data:

aluminium, copper, zinc, steel	mm	0,4 - 0,8
stainless steel	mm	0,4 - 0,5
panel width	mm	300- 800
length	mm	2200
width	mm	1300
height	mm	860
weight K25PFR/800	kg	300
weight K25-PQLB/800	kg	360
seam height	mm	25
working speed	± m/min	11
capacity	kW	0,75
voltage	V	230 or 115

additional options for K 25-PRF

		Art. no.
■ guillotine shear 800	K25-QMT	91410 *
■ mech. measuring device	K25-MV	91416 *
■ metal shear slitter incl. bracket	K25-BSEW	91430 *
■ limit switch with 12m cable	K25-EAS	91420
■ set of stiffening rolls	K25-SR	91440
■ expanding roller conveyor	K25-SBR	91480
■ decoiler up to 2 tons	K1-CW/100	91201
■ coil trolley up to 250 kg	K1-AG	91280

* included in the complete version K25-PQLB/800

Panel Variations

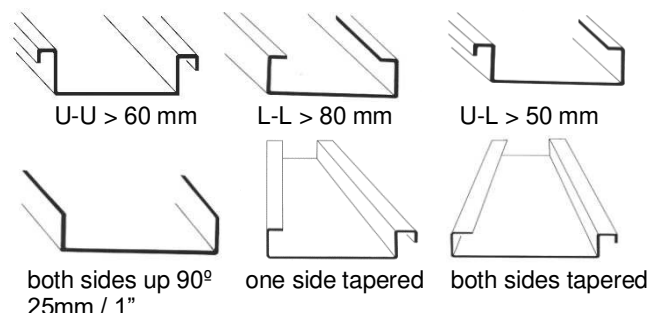

PROFIMA Details and Accessories



Electric Mechanical Measuring Device K25-MV

Switches the pan former off, after reaching the programmed length. The last programmed length stays in the counter. Simply press the reset lever once to repeat the same length.

Pre-selection Counter with one preset adding mode and switch for operation or non - operation.

To produce panels on top of the roof, the supporting legs can be adjusted to the slope of the roof.



Guillotine Shear K25-QMT.

Cuts the panels at the exit, therefore short panels can be manufactured for walls from the coil without difficulties. The guillotine shear cuts the panel without distortion, burr-free and not damaging the surface of pre-painted or patinated material. Extremely short panels possible.

A big advantage over other Pan formers, where the cut for panels is at the entrance guide and the material has to be fed into the machine in single operation.

Width adjustment by hand wheel by a scale, exact to the mm.



Electric Metal Slitter Shear K25-BSEW with entrance guide and material guide.

To produce narrow panels from a wider coil in one operation without distortion and deforming the material. When disassembled from the pan former, the Metal Shear can be used for hand-cutting.

These are the advantages against stationary cutting-rolls.

Stiffening Rolls K25-SR (Two pairs)

For additional rigidity use the adjustable stiffening rolls. The maximum lowest point 1.5 mm, adjusted or disengaged through an eccentric shaft. Possibility to additional ribs, more than two.

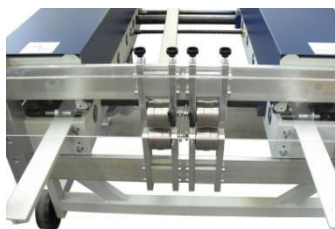

Pan former VARIO PROFI K25-VP

Indispensable for all Roofers
Ideal as a supplement to any Roll form Equipment



VARIO PROFI K25-VP

Entrance guides are adjustable with scales on both sides for any kind of material and hardness for exact panel measurements.

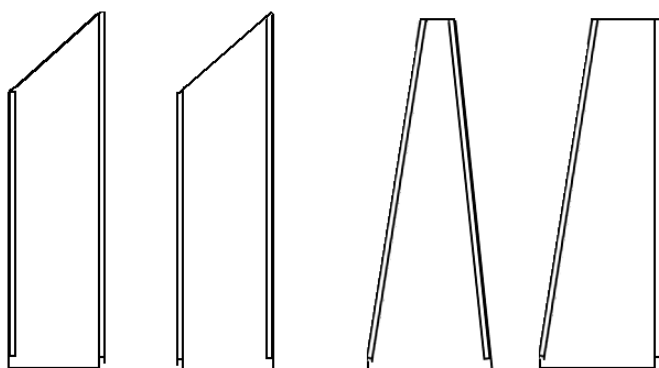

ideal for tapered pointed and cut out panels

Panel Variations

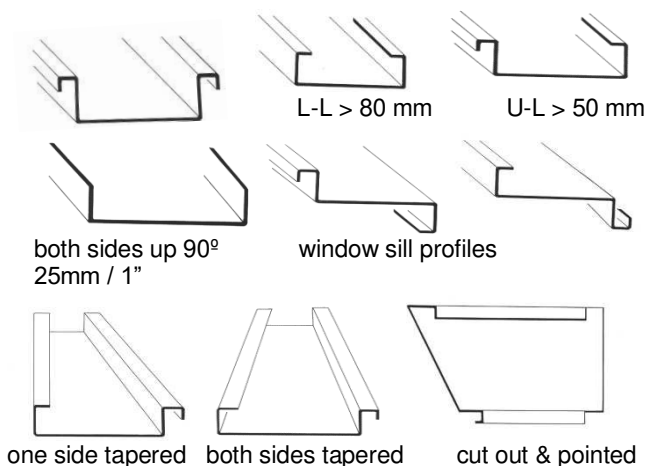

all variations of cut-outs on both sides or pointed shapes can be roll-formed

Type	Art.no.:	0,75kW	kg
K25-VP	91460	230V	255
	91461	115V	

steel, aluminium, copper, zinc	mm ±	0,4 - 0,8
stainless steel	mm ±	0,4 - 0,5
length	mm ±	2270
width	mm ±	1100
height	mm ±	1160
machine length	mm ±	1040
machine height	mm ±	800
machine width	mm ±	1100
length incl. guides	mm ±	2270
width incl. guides	mm ±	750
panel width min. ±	mm ±	50
panel width max.	mm ±	1250
panel length min.	mm ±	330
seam height	mm ±	25
working speed	m/min ±	11

DRACO offers the finest, high-quality, operator-friendly Rolling Equipment on the market.

This Roll form Machine VARIO PROFI K25-VP is a supplement to any Roll form Equipment and is ideal for both on-site and workshop use.

The VARIO PROFI K25-VP is equipped with 2 castors, 2 crane lifting eyes and control box. Working height 80 cm, therefore easy access to left and right forming stations.

The VARIO PROFI 25 has been designed to form under cloak or over cloak (female and male) profiles on pre-cut and shaped panels one side at a time. This allows straight and tapered panels to be formed with different profiles down to the smallest width of 50 mm (see "Panel Variations"). Pan former VARIO PROFI K25-VP is able to produce panels from 50 mm min. to any width.

- forming on one side only, fast and without any adjustments.
- no width adjustments necessary.
- tapered panels down to width 50 mm/2".
- seam height 25 mm/1".
- easy to transport from workshop to site.



Arch-Bending-Machine

Arch-Bending-Machine PROFI-FORM K25-RBPE (variable speed)

The ARCH BENDING MACHINE has been developed for bending profiled panels, height 25 mm to a minimum radius of 600 mm.

Type	Art. no.:	0,37kW	kg
K25-RBPE	91475	230 V	220
	91476	115 V	

Technical details:

aluminium, copper, zinc, steel	mm	0,4 - 0,8
stainless steel	mm	0,4 - 0,5
length	mm	1050
width	mm	1050
height	mm	1480
weight	kg	320
panel width	mm	240- 780
seam height	mm	25
radius of panels min.	mm	600
working speed K25-RBPE ±	m/min	2 - 12



The PROFI FORM K 25 Arch Bending Machine has been developed for curving profiled roofing panels produced with any pan former.

Profiled panels from 240 mm to 780 mm in width can be curved to a minimum radius of 600 mm in one pass. All adjustments are positioned to one side of the machine with scale accuracy and for uniform pressure adjustments.

The PROFI FORM K 25 will produce curved panels, curved to flat and flat to curved, plus tapered panels in two operations.

The PROFI FORM K 25 is the ideal machine for fast curving of profiled panels for arches, domes, dormers, barrel vaulted roofs etc.

Four castors are mounted to the frame for easy transportation.

The Arch Bending Machine will be delivered with a variable speed control. The working speed can be adjusted from 2-12 m/min., for effective working in curving long panels.

- easy to handle
- no damage to painted or coated sheets
- complete equipped, no options or extra's necessary
- ergonomic working height
- exact pressure adjustment
- emergency switch





Decoiler K1-CW



Decoiler K1-CW/AQ



K1-CW/AQ/LSE/S



K1-LAQ

Mobile Decoiler K1-CW

	Art. No.:	width	coil-width	max.
K1-CW/100	91201	1000 mm	800 mm	2000 kg
K1-CW/125	91202	1250 mm	1000 mm	1500 kg
K1-CW/150	91205	1500 mm	1250 mm	1500 kg

- decoiler K1-CW with core, two steering and two parking castors
- core has **5** adjustable arms, avoiding marks, dents or scratch marks, when the coil is clamped or decoiled
- core I.D. K1-CW/100: Ø 230-510 mm
- core I.D. K1-CW/125: Ø 250-515 mm
- core I.D. K1-CW/150: Ø 360-650 mm

Mobile Decoiler K1-CW/AQ including Decoiling & Cross Cut Attachment

	Art. No.:	width	coil-width	max.
K1-CW/100AQ	91241	1000 mm	800 mm	2000 kg
K1-CW/125AQ	91242	1250 mm	1000 mm	1500 kg
K1-CW/150AQ	91245	1500 mm	1250 mm	1500 kg

Technical details decoiler see K1-CW ↑

Technical details cross cut attachment AQ see also next page ⇒

- **max. cutting capacity: 1,0 mm, stainl.: 0,5 mm**
- **max. transport (unroll) capacity AQ: 750 kg**
- **max. coil outside diameter: 800 mm**

Mobile Decoiler K1-CW/AQ/LSE/S cpl. including Decoiling & Cross Cut Attachment and cpl. length cut Slitter Device.
Ideal for mobile on-site cutting & slitting

	Art. No.:	width	coil-width
K1-CW/100AQ/LSE/S	91271	1000 mm	800 mm
K1-CW/125AQ/LSE/S	91272	1250 mm	1000 mm
K1-CW/150AQ/LSE/S	91275	1500 mm	1250 mm

Incl. Cordless Metal Shear Set AK3514-2 for length cut slitting

Easy to move, easy to transport, easy to decoil, easy to cut. Cross- and length wise cutting on site or in the workshop

Technical details decoiler, see K1-CW ↑

Technical details cross cut attachment AQ see also next page ⇒

Mechanical measuring device K1-LAQ

	Art. No.	max. length	preciseness
K1-LAQ	91260	999,99 m	½ cm

Decoilers and Cores are also available in special dimensions. Inform us about your requirements.

Decoiling & Cross Cut Attachment K1 – AQ

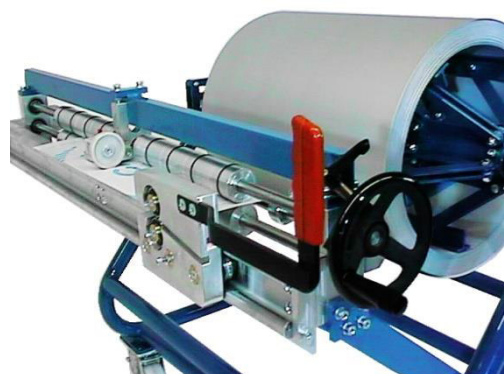

Decoiling & Cross Cut Attachment K1-AQ
(Pic. incl. opt. measuring device)



Slitter attachment K1-LSE for decoiler or workbench



K1-CSg



K1-AG with K1-AGb

The Slitter Attachment K1-AQ can be fitted to any DRÄCO Decoiler or can be mounted on to a workbench. When ordering, please state item and type number on decoiler label.

	Art. No.:	width	Adv. coil-width
K1-100AQ	91251	1000 mm	800 mm
K1-125AQ	91252	1250 mm	1000 mm
K1-150AQ	91255	1500 mm	1250 mm

Technical details, cutting capacity:

aluminium, copper, zinc	mm	1,0
galvanised steel	mm	1,0
stainless steel	mm	0,5
pull capacity ±	kg	750
weight of slitter attachment ±	kg	30

- rubber transportation rolls for a better grip
- wheel for forward & reverse transportation of the coil-material with clamping device
- collars adjustable for coil width
- cutting rolls can be re-sharpened
- ball bearings are maintenance free

Lengths cut slitter device K1-LSE

	Art. No.:	without shear
K1-LSE100	91268	for K1-100AQ
K1-LSE125	91269	for K1-125AQ
K1-LSE150	91270	for K1-150AQ

for all Shears Series 20.. and 35.. with mounting hole

Quick-Strap K1-CSg

	Art. No.:	measurements mm
K1-CSg	91277	± 2500 x 48

No more damaged coils. The 2500 x 48 mm wide strap eliminates damage caused by wire, string, rope or tape. Quick fastening and release using Velcro fastening and is ideal for work-shops and site- work, also for safe transporting of coils, to and from the site.

Coil Trolley K1-AG

- easy transportation without danger of coils up to 1000 mm, or 1250 mm width
- simple & easy decoiling

	Art. No.:	capacity kg	weight kg
K1-AG100	91280	200	24
K1-AG125	91281	200	28

Guide K1-AGb for Coil Trolley

	Art. No.:	coil width mm	Weight kg
K1-AGb100	91285	0 - 900	4,5
K1-AGb125	91286	0 - 1160	5,0



K10-FH

Fixed Clip Former K10-FH

Item No.:	91700
-----------	-------

A hand operated tool to manufacture fixed clips from metal pieces. Bending and punching 2 holes, height 25 mm for fixed cleat. Also available for other panel heights.



K10-FHS

Fixed Clip Former K10-FHS

Item No.:	91710
-----------	-------

A hand operated tool to manufacture fixed clips from metal strips. Bending, punches holes, perforates and cuts in one operation. Height 25 mm, width of material 39 mm.



K10-LH

Laying Clip Former K10-LH

Item No.:	91730
-----------	-------

Material 39 mm width, punches holes, bends and cuts off. Measurements 39x35x11 mm for flashings, air intakes, verge and valley panels.



K10-HS

Y-Clip Former K10-HS

Item No.:	91720
-----------	-------

Material 39 mm wide, to make Y-shape cleats. Height 75 mm. Punches holes, bends and cuts material off.

Clips/Cleats

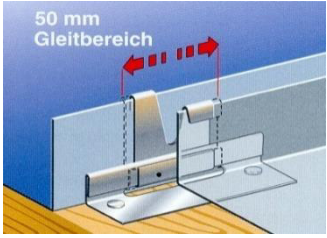
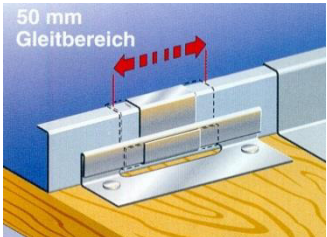
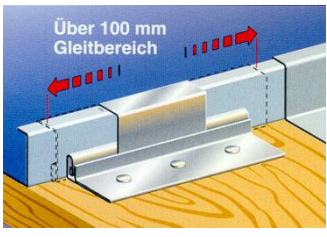
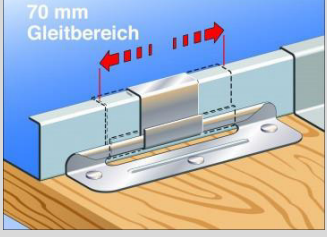
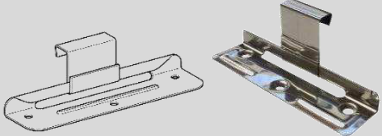
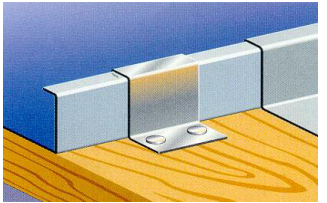
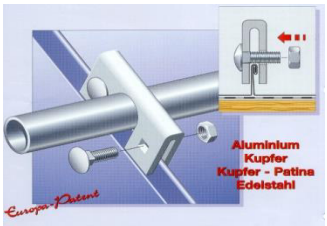
Item/Clip	Type	Item No.:	Description	Pieces per package
	SM-HS	91800	Stainless steel clip expansion Y-shape top and bottom part assembled, 50 mm expansion.	400
	SM-ESe 50 mm	91805	Stainless steel expansion clip, top and bottom part assembled, 50 mm expansion.	400
	SM-ESI 70mm	91807	Same as above, but 70 mm expansion, top and bottom part assembled	
	SM-ESe30 50 mm	91835	Same as SM-ESe, <u>but for 30 mm Seam Height.</u>	
	SM-ES	91808	Stainless steel expansion clip, 100 mm expansion, heavy bottom part, assembled. Advice: This clip is used for panels over 10 meter length.	100
	SM-ESL38 NATO		Stainless steel expansion clip 70 mm, for <u>Seam Height 38 mm, 1.5"</u> , made of special Stainless Steel 1.4401 AISI 316 	300
	SM-Efk	91813	Stainless steel fixed clip, width 30 mm.	1000
	SM-Efk30	91833	Same as SM-Efk, <u>but for 30 mm (1.5") Seam Height.</u>	1000
	SM-EFg	91815	Stainless steel fixed clip, width 50 mm, fixing holes.	500
	SM-KA	91851	Snow Safety Clamp Aluminium	15
	SM-KC	91853	Snow Safety Clamp Copper	20
	SM-KE25	91855	Snow Safety Clamp stainless Steel With screws and nuts assembled. Saves about 50% of time when installing.	15

Standard clip height 25 mm (1"). The clips are produced to German standards for the roofing technology. The material quality stainless steel material no. 1.4301 (V4A).

Please ask for quantity discounts. Special heights on request.



FAX-ORDER-SERVICE



+49-7153-8217-66

Your address/stamp:

Your Order # _____

COPY it - FILL it OUT - FAX it or Mail it

Art. No.	Description	(Voltage)	Quantity	Price/unit

When ordering please state item number, description and voltage (machines)!

_____ Date

_____ Signature

To:

Max Draenert Apparatebau GmbH & Co KG

Electric – Cordless – Pneumatic Tools – Machines for Roof & Wall

Germany

Building I: **Administration**
Production

D-73777 Deizisau
D-73779 Deizisau

P.O.Box 1120
Gutenbergstrasse 15-17

Phone
Fax

+49-7153-8217-0
+49-7153-8217-66

E-Mail:

draenert@dracotools.com

Building II: **Training Centre**

D-73779 Deizisau

Seewiesenweg 1

Internet

www.dracotools.com

How to find us:

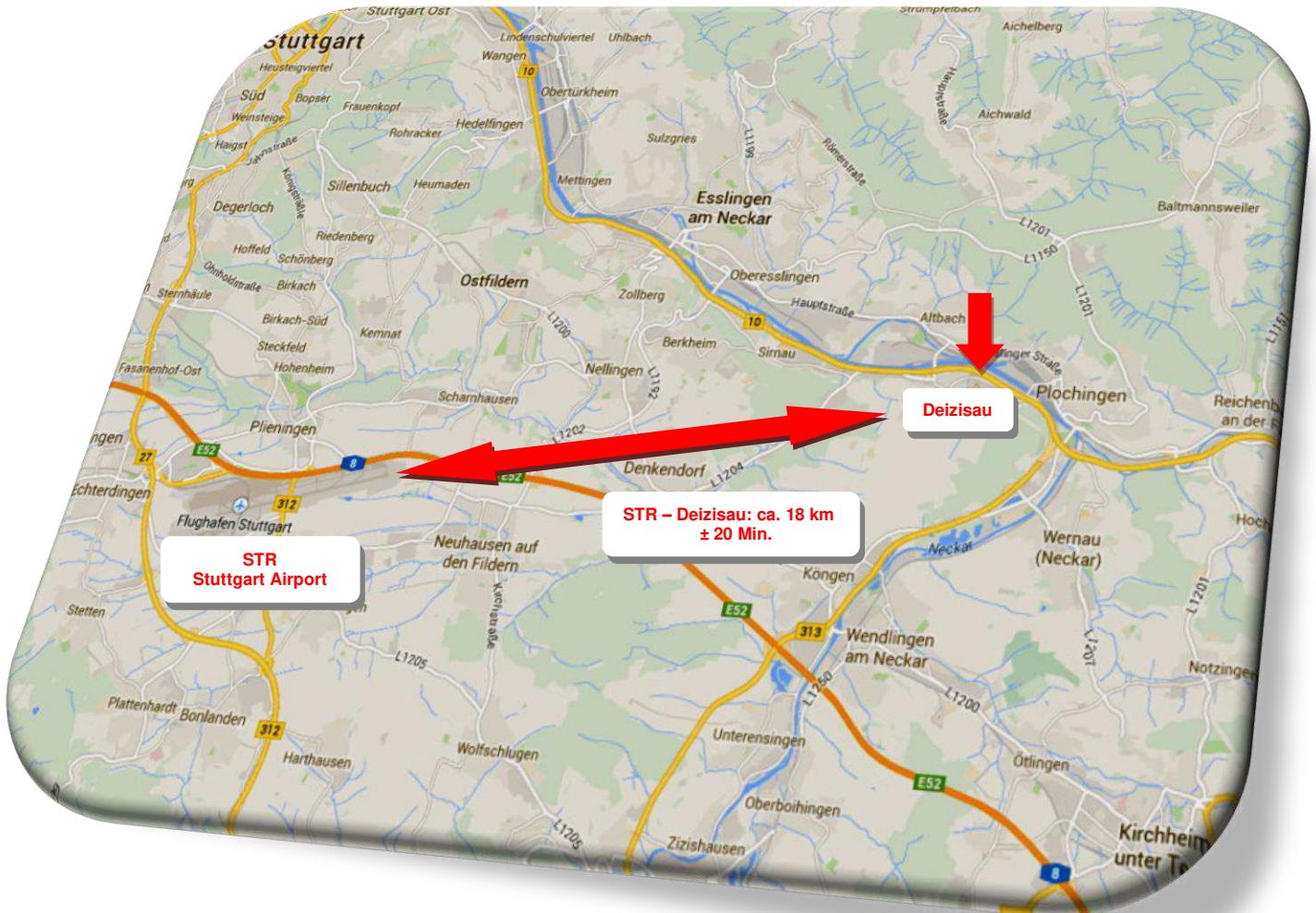

Max Draenert Apparatebau GmbH & Co KG

Electric – Cordless – Pneumatic Tools – Machines for Roof & Wall

Germany

Administration	D-73777 Deizisau	P.O.Box 1120	Phone	+49-7153-8217-0
Building I: Production	D-73779 Deizisau	Gutenbergstrasse 15-17	Fax	+49-7153-8217-66
Building II: Training Centre	D-73779 Deizisau	Seewiesenweg 1	E-Mail:	draenert@dracotools.com
			Internet	www.dracotools.com

Engineered and Made in Germany



we are looking forward to hear from you

Max Draenert Apparatebau GmbH & Co. KG
Gutenbergstrasse 15-17
D-73779 DEIZISAU / Germany
Phone : +49-(0)7153-8217-0
Fax : +49-(0)7153-8217-66
E-Mail : info@dracotools.com
www.dracotools.com



www.dracotools.com